

## Description

The AVD85-48S3V3 is a single output DC/DC converter with standard sixteenth-brick outline and pin configuration. It delivers up to 25A output current with 3.3V output voltage. Above 91.5% ultra-high efficiency and excellent thermal performance makes it an ideal choice to supply power in telecom and datacom. It can work under -40°C ~ +85°C.



- Output over voltage protection
- Over temperature protection

## Operational Features

- Delivers up to 25A output current
- Ultra-high efficiency 91.5% typ. at full load
- Wide input range: 36V ~ 75V
- Excellent thermal performance
- No minimum load requirement
- Basic isolation
- High power density
- Low output noise
- reflow soldering-able
- RoHS 6 compliant

## Mechanical Features

- Industry standard sixteenth-brick pin-out outline

## Control Features

- Remote control function (negative logic)
- Remote output sense
- Trim function: 80% ~ 110%

## Safety & EMC

- Meets basic insulation requirements of IEC/EN/UL/CSA 60950
- UL/CSA 60950 recognized and certified to EN 60950
- Meets the Low Voltage directives 2006/95/EEC with the Amendment Directive 93/68/EEC which facilitates CE marking in user's end product
- Approved by UL and TUV
- Materials meet UL94,V-0 flammability rating
- Meets conducted emission's requirements of EN55022 Class A with external filter.

## Protection Features

- Input under voltage lockout
- Output over current protection
- Output short circuit protection

## Electrical Characteristics

(TA=25°C, airflow rate=300 LFM, Vin=48Vdc, nominal Vout unless otherwise noted.)

Parameter		Min.	Typ.	Max.	Unit	Notes & Conditions
<b>Absolute max. ratings</b>						
Input voltage	Non-operating			100	V	100ms
	Operating			80	V	Continuous
Operating temperature		-40		85	°C	
Storage temperature		-55		125	°C	
Voltage at remote ON/OFF pin		-0.3		5	V	
<b>Input characteristics</b>						
Operating input voltage range		36	48	75	V	
Input under-voltage lockout	Turn-on voltage threshold	31		36	V	
	Turn-off voltage threshold	30		35	V	
	Lockout voltage hysteresis	1		3	V	
Max. input current				3	A	36Vin, full load
No-load input current			0.04		A	
Standby Input current			0.01		A	Remote OFF
Input reflected ripple current				40	mA	Through 12µH inductor; Figure 15
Recommended input fuse				5	A	Fast blow external fuse recommended; Figure 11
Input filter component values (CL)			0\1		µF\µH	Internal values
Recommended external input capacitance			100		µF	Low ESR capacitor recommended; Figure 11
<b>Output characteristics</b>						
Output voltage set point (standard option)		3.25	3.3	3.35	V	48Vin, half load
Output voltage line regulation				0.2	%	
				6.6	mV	
Output voltage load regulation				0.5	%	
				16.5	mV	
Output voltage temperature regulation				0.02	%/°C	

Parameter		Min.	Typ.	Max.	Unit	Notes & Conditions
Total output voltage range		3.2	3.3	3.4	V	Over sample, line, load, temperature & life
Output voltage ripple and noise			85	120	mVpp	Figure 2; Test condition: 10u tantalum(ESR≤100 mΩ)// 1u ceramic capacitor; Figure 15
Output voltage ripple and noise			85		mVpp	Test condition: minimum output capacitor//1u ceramic capacitor; Figure 15
Operating output current range		0		25	A	
Output DC current-limit inception		27		37	A	Hiccup: auto-restart when over-current condition is removed
Output capacitance		220	470	4000	μF	High frequency and low ESR is recommended
<b>Dynamic characteristics</b>						
Dynamic response	25% ~ 50% ~ 25% $I_{o,max}, 0.1A/\mu s$		60		mV	Figure 4 Test condition: see Figure 11
	50% ~ 75% ~ 50% $I_{o,max}, 0.1A/\mu s$					
	Settling time		100		μs	Recovery to within 1% $V_{o,nom}$
	25% ~ 50% ~ 25% $I_{o,max}, 1A/\mu s$		150		mV	Figure 5 Test condition: see Figure 11
	50% ~ 75% ~ 50% $I_{o,max}, 1A/\mu s$					
	Settling time		100		μs	Recovery to within 1% $V_{o,nom}$
Turn-on transient	Rise time			50	ms	Full load, Figure 6
	Turn-on delay time			100	ms	
	Output voltage overshoot			5	% $V_o$	
<b>Efficiency</b>						
100% load			91.5		%	Figure 1
50% load			91.5		%	Figure 1

## Electrical Characteristics (Continued)

Parameter	Min.	Typ.	Max.	Unit	Notes & Conditions	
<b>Isolation characteristics</b>						
Isolation voltage (conditions: 1mA for 60s, slew rate of 1500V/10s)	1500			V	Basic insulation, pollution degree 2, input to output	
				V	Basic insulation, pollution degree 2, input to baseplate	
				V	Functional insulation, pollution degree 2, output to baseplate	
<b>Feature characteristics</b>						
Switching frequency	230	240	250	kHz		
Remote ON/OFF control (positive logic)	Off-state voltage	-0.3		1.2	V	See Figure 12
	On-state voltage	3.5		5	V	
Remote ON/OFF control (negative logic)	Off-state voltage	3.5		5	V	
	On-State Voltage	-0.3		1.2	V	
Output voltage trim range	2.64		3.63	V	See <i>Trim Characteristics</i> of <i>Application Note</i>	
Output over-voltage protection	120		160	%Vo,nom	Hiccup: auto-restart when over-voltage condition is removed	
Over-temperature shutdown		109		°C	Auto recovery; over-temperature protect(OTP) test point: see Figure 10	
Over-temperature hysteresis		10		°C		
+SENSE			5	%Vo		
-SENSE			5	%Vo		
<b>Reliability characteristics</b>						
Calculated MTBF (telcordia )		2.0		10 <sup>6</sup> h	Telcordia SR-332-2006; 80% load, 300LFM, 40°C T <sub>a</sub>	

## Electromagnetic Compatibility Requirements

Test Item	Regulations	Criteria	Notes & Conditions
Conducted Emission	EN 55022 DC input port, Class A Limits		See EMC test conditions
Immunity to Electrostatic Discharge	IEC/EN61000-4-2 Enclosure Port, Level 3	B	
Immunity to Electrical Fast Transient	IEC/EN61000-4-4 DC input port, Level 3	B	
Immunity to Surges	IEC/EN61000-4-5 DC input port Line to Ground(earth): 600V Line to Line: 600V	B	
Immunity to Continuous Conducted Interference	IEC/EN61000-4-6 DC input port, Level 2	A	
Immunity to Voltage Dips and Short Interruptions and Voltage Variations	EN 61000-4-29 DC input port	B	

Criterion A: Normal performance during and after test.

Criterion B: For EFT and surges, low-voltage protection or reset is not allowed. Temporary output voltage fluctuation ceases after disturbances ceases, and from which the EUT recovers its normal performance automatically.

For Dips and ESD, output voltage fluctuation or reset is allowed during the test, but recovers to its normal performance automatically after the disturbance ceases.

Criterion C: Temporary loss of output, the correction of which requires operator intervention.

Criterion D: Loss of output which is not recoverable, owing to damage to hardware.

## Qualification Testing

Parameter	Unit (pcs)	Test condition
Halt test	4 ~ 5	$T_{a,min}$ -10°C to $T_{a,max}$ +10°C, 5°C step, $V_{in}$ = min to max, 0 ~ 105% load
Vibration	3	Frequency range: 5Hz ~ 20Hz, 20Hz ~ 200Hz, A.S.D: $1.0m^2/s^3$ , -3db/oct, axes of vibration: X/Y/Z Time: 30min/axes
Mechanical shock	3	30g, 6ms, 3axes, 6directions, 3time/direction
Thermal shock	3	-40°C to 100°C, unit temperature 20cycles
Thermal cycling	3	-40°C to 55°C, temperature change rate: 1°C/min, cycles: 2cycles
Humidity	3	40°C, 95%RH, 48h

Parameter	Unit (pcs)	Test condition
Solder ability	15	IPC J-STD-002C-2007

## Characteristic Curves

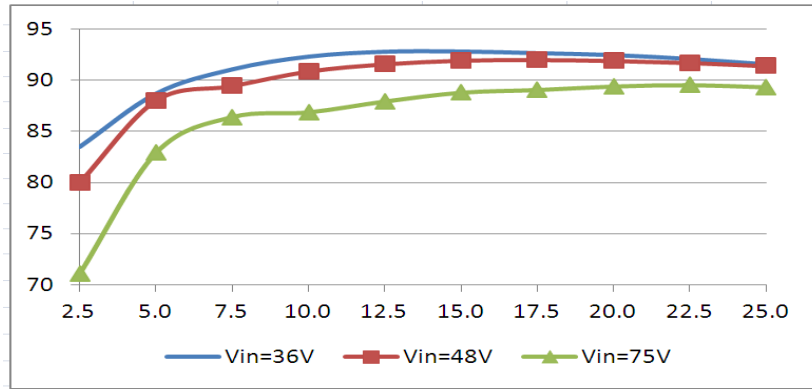

Figure 1 Efficiency vs. output current,  $T_a=25^{\circ}\text{C}$ , 200LFM,  $V_o=3.3\text{V}$

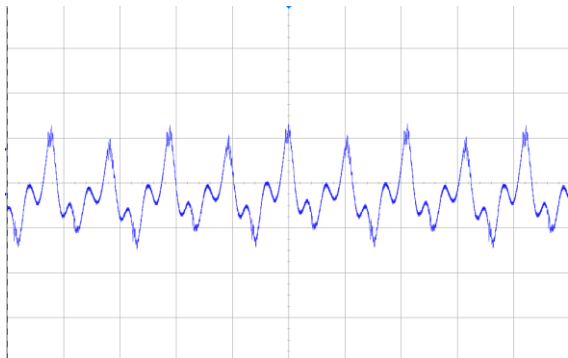

Figure 2 Output ripple & noise (2 $\mu\text{s}/\text{div}$ , 20mV/div), see Figure 15 for test configuration

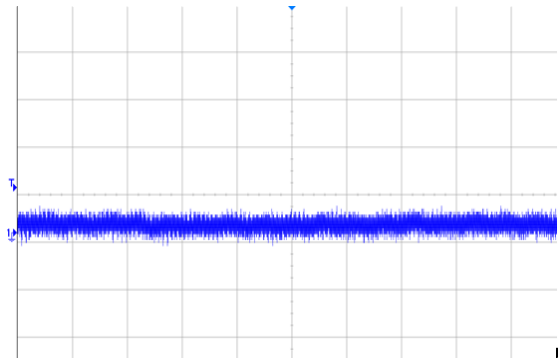

Figure 3 Input reflected ripple current (50 $\mu\text{s}/\text{div}$ , 50mA/div), see Figure 15 for test configuration

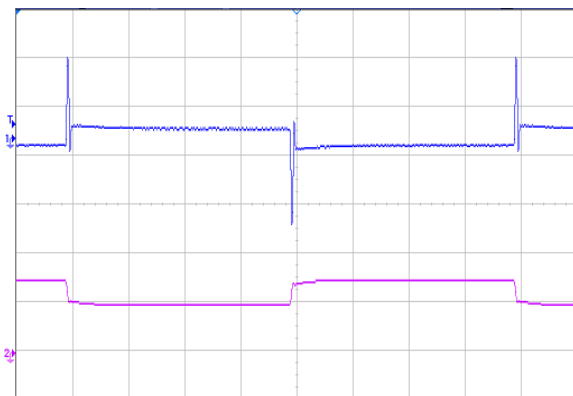

Figure 4 Dynamic response for 25% load step (50% ~ 75% ~ 50%) and 0.1A/ $\mu\text{s}$  slew rate, (1ms/div), see Figure 11 for test configuration; CH2-output current (10A/div);CH1-output voltage (10mV/div)

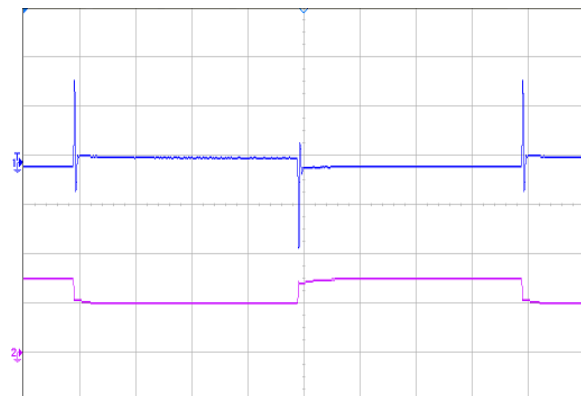

Figure 5 Dynamic response for 25% load step (50% ~ 75% ~ 50%) and 1A/ $\mu\text{s}$  slew rate, (1ms/div), see Figure 11 for test configuration; CH2-output current (10A/div);CH1-output voltage (10mV/div)

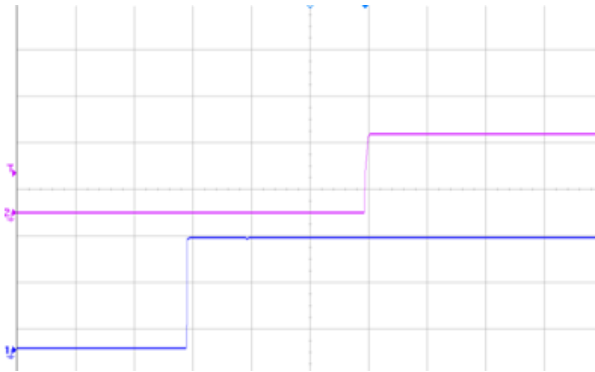

Figure 6 Output voltage startup by power on, (20ms/div), see Figure 11 for test configuration; CH1-input voltage (20V/div);CH2-output voltage (2V/div)

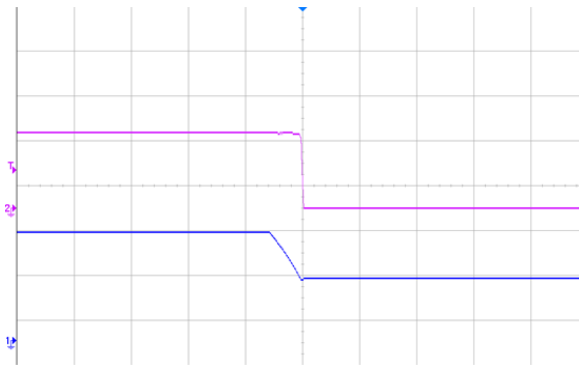

Figure 7 Output voltage shut down by power off, (100ms/div), see Figure 11 for test configuration; CH1-input voltage (20V/div);CH2-output voltage (2V/div)

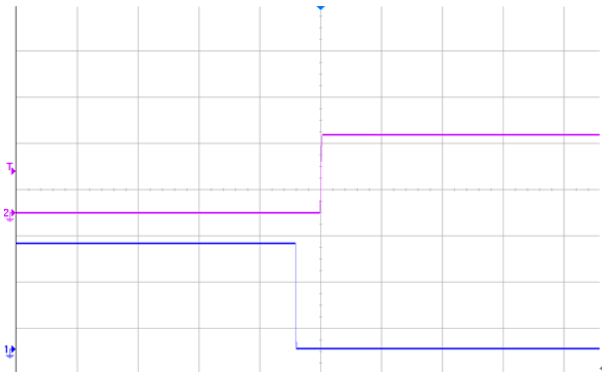

Figure 8 Output voltage startup by remote ON, (100ms/div), see Figure 11 for test configuration; CH1-remote ON (2V/div);CH2-output voltage (2V/div)

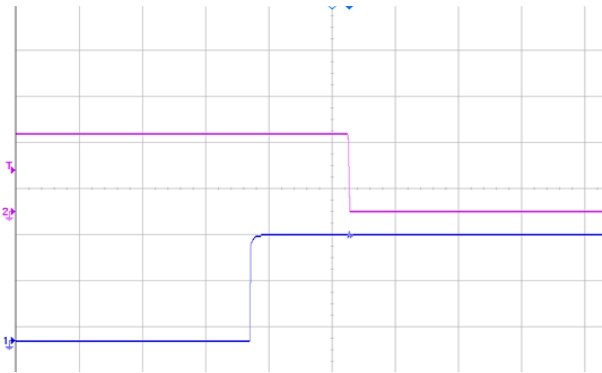

Figure 9 Output voltage shutdown by remote OFF, (50ms/div), see Figure 11 for test configuration; CH1-remote ON (2V/div);CH2-output voltage (2V/div)



Figure 10 OTP test point

# Application Note

## Typical Application

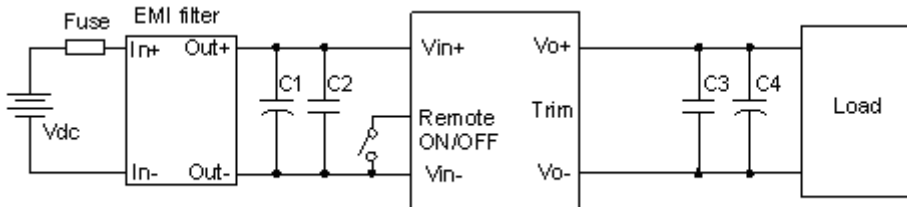

Figure 11 Typical application

C1: 100 $\mu$ F/100V electrolytic capacitor; P/N: UPM2A101MPD(Nichicon) or equivalent caps  
 C2, C3: 1 $\mu$ F/100V X7R ceramic capacitor, P/N: C3225X7R2A105KT0L0U (TDK) or equivalent caps  
 C4:470 $\mu$ F electrolytic capacitor, P/N: UPM1A471MHD (Nichicon) or equivalent caps  
 Fuse: External fast blow fuse with a rating of 5A. The recommended fuse model is 0314005.P from LITTLEFUSE.

## Remote ON/OFF

Negative remote ON/OFF logic is available in AVD85-48S3V3. The logic is CMOS and TTL compatible.

The voltage between pin Remote ON/OFF and pin Vin- must not exceed the range listed in table “Feature characteristics” to ensure proper operation. The external Remote ON/OFF circuit is highly recommended as shown in figure 12.

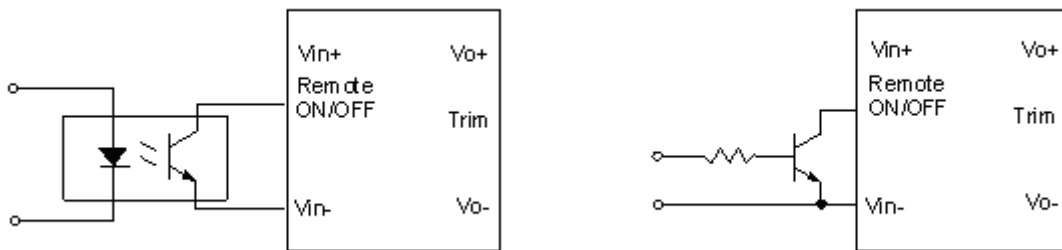

Isolated remote ON/OFF circuit

non-isolated remote ON/OFF circuit

Figure 12 external Remote ON/OFF circuit



### Trim Characteristics

Connecting an external resistor between Trim pin and Vo- pin will decrease the output voltage. While connecting it between Trim and Vo+ will increase the output voltage. The following equations determine the external resistance to obtain the trimmed output voltage.

$$R_{adj-down} = \frac{510}{\Delta} - 10.2(K\Omega)$$

$$R_{adj-up} = \frac{5.1 \times V_{nom} \times (100 + \Delta)}{1.225 \times \Delta} - \frac{510}{\Delta} - 10.2(K\Omega)$$

$\Delta$  : Output e rate against nominal output voltage.

$$\Delta = \frac{100 \times (V_{nom} - V_0)}{V_{nom}}$$

$V_{nom}$  : Nominal output voltage.

For example, to get 3.63V output, the trimming resistor is

$$\Delta = \frac{100 \times (V_{nom} - V_0)}{V_{nom}} = \frac{100 \times (3.63 - 3.3)}{3.3} = 10$$

$$R_{adj-up} = \frac{5.1 \times 3.3 \times (100 + 10)}{1.225 \times 10} - \frac{510}{10} - 10.2 = 89.9(K\Omega)$$

When trimming up, the output current should be decreased accordingly so as not to exceed the maximum output power .

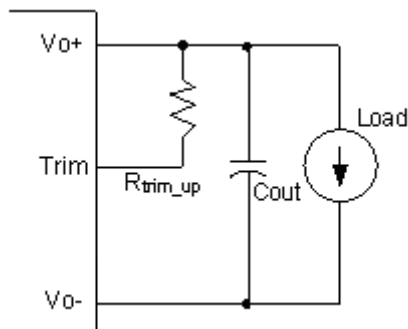

Figure 13 Trim up

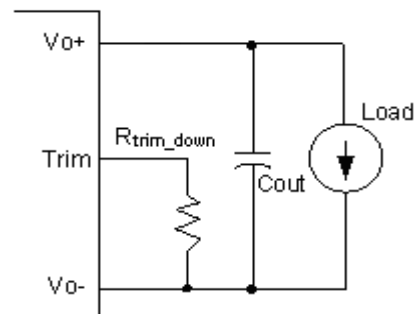

Figure 14 Trim down

## Input Ripple & Inrush Current And Output Ripple & Noise Test Configuration

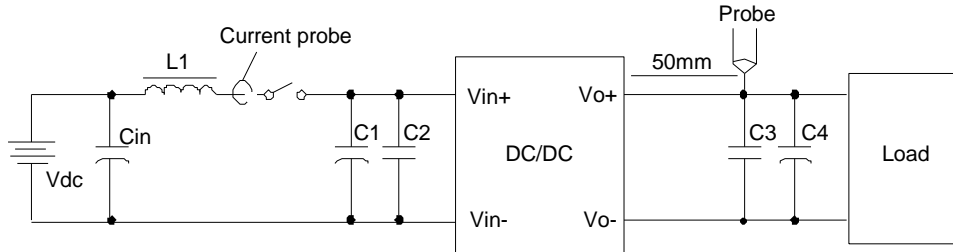

Figure 15 Input ripple & inrush current, ripple & noise test configuration

Vdc: DC power supply

L1: 12 $\mu$ H

Cin: 220 $\mu$ F/100V typical

C1 ~ C4: See Figure 11

Note: Using a coaxial cable with series 50 $\Omega$  resistor and 0.68 $\mu$ F ceramic capacitor or a ground ring of probe to test output ripple & noise is recommended.

## EMC Test Conditions

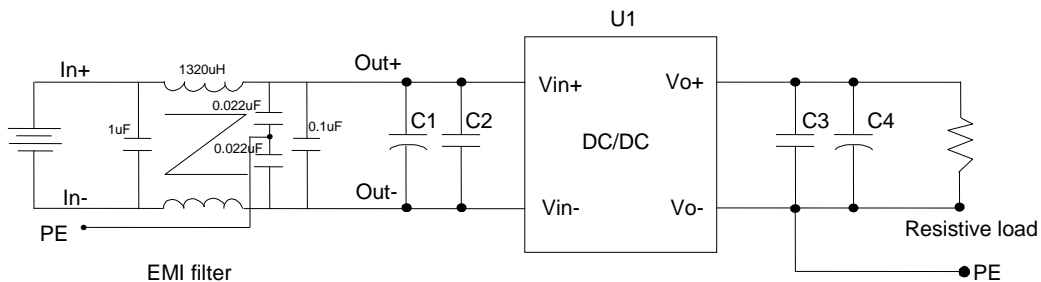

Figure 16 EMC test configuration

U1: Module to test, AVD85-48S3V3

C1 ~ C4: See Figure 11

### Thermal Considerations

The converter is designed to operate in different thermal environments and sufficient cooling must be provided. Proper cooling of the DC/DC converter can be verified by measuring the temperature at the test point as shown in the Figure 17. The temperature at this point should not exceed the max values in the table 1.

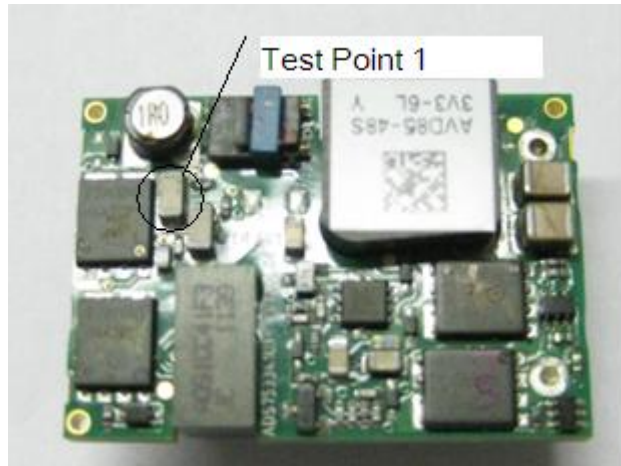

Temperature test point on FR-4 board

Figure 17 Temperature test points

Table 1 Temperature limit of the test points

Test Point	Temperature limit
Test point 1	118°C

For a typical application, figure 18 shows the derating of output current vs. ambient air temperature at different air velocity.

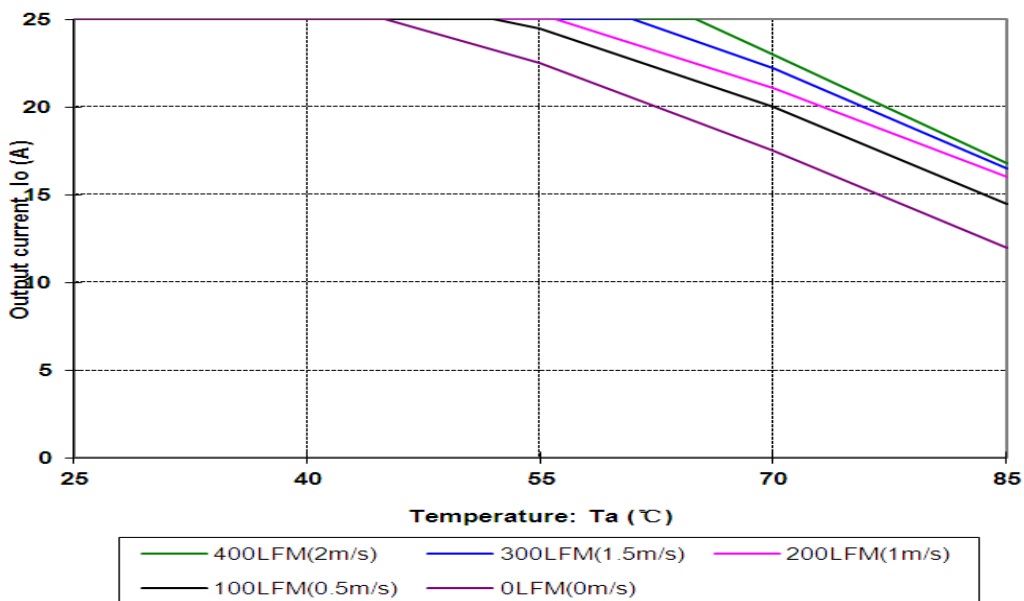
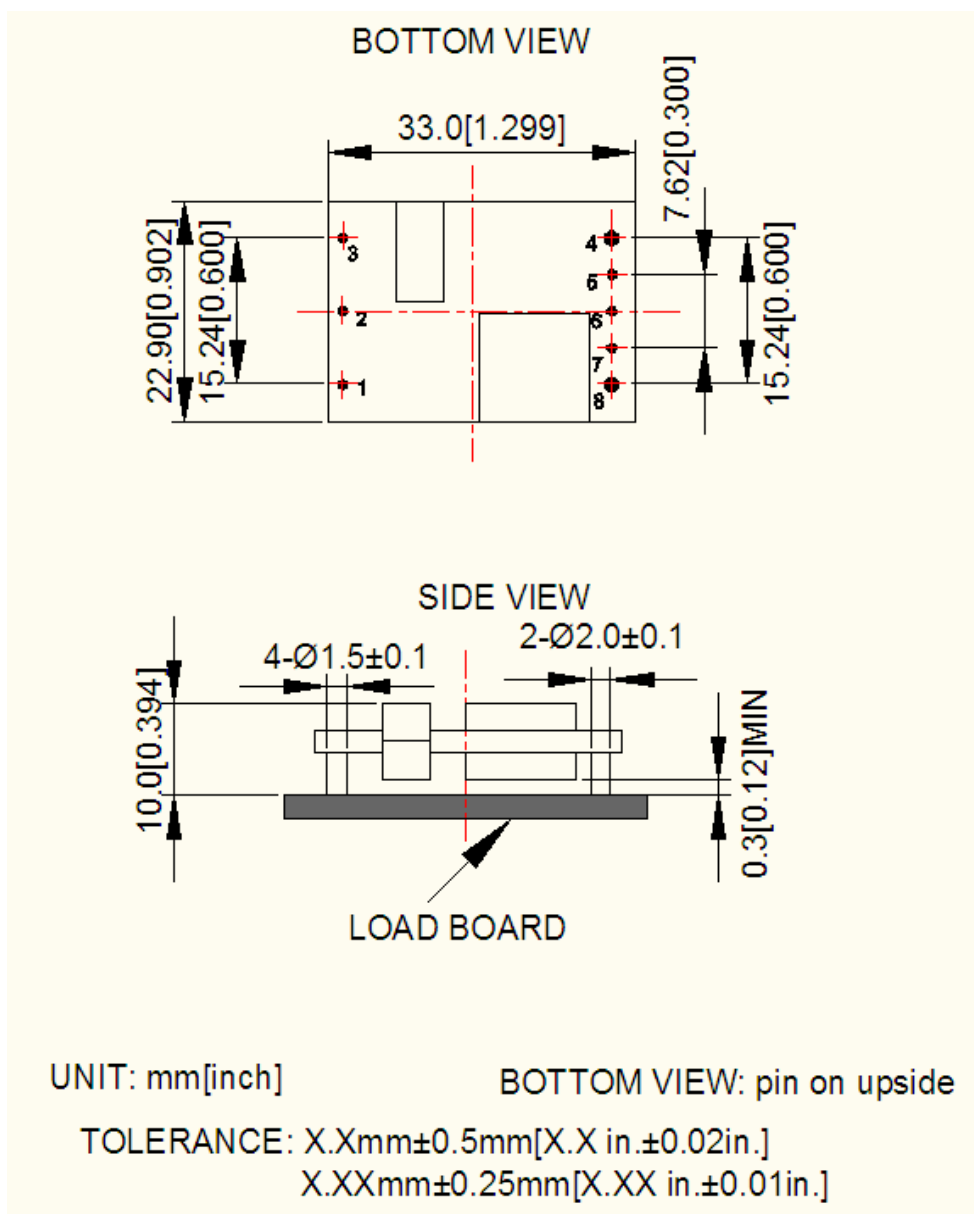
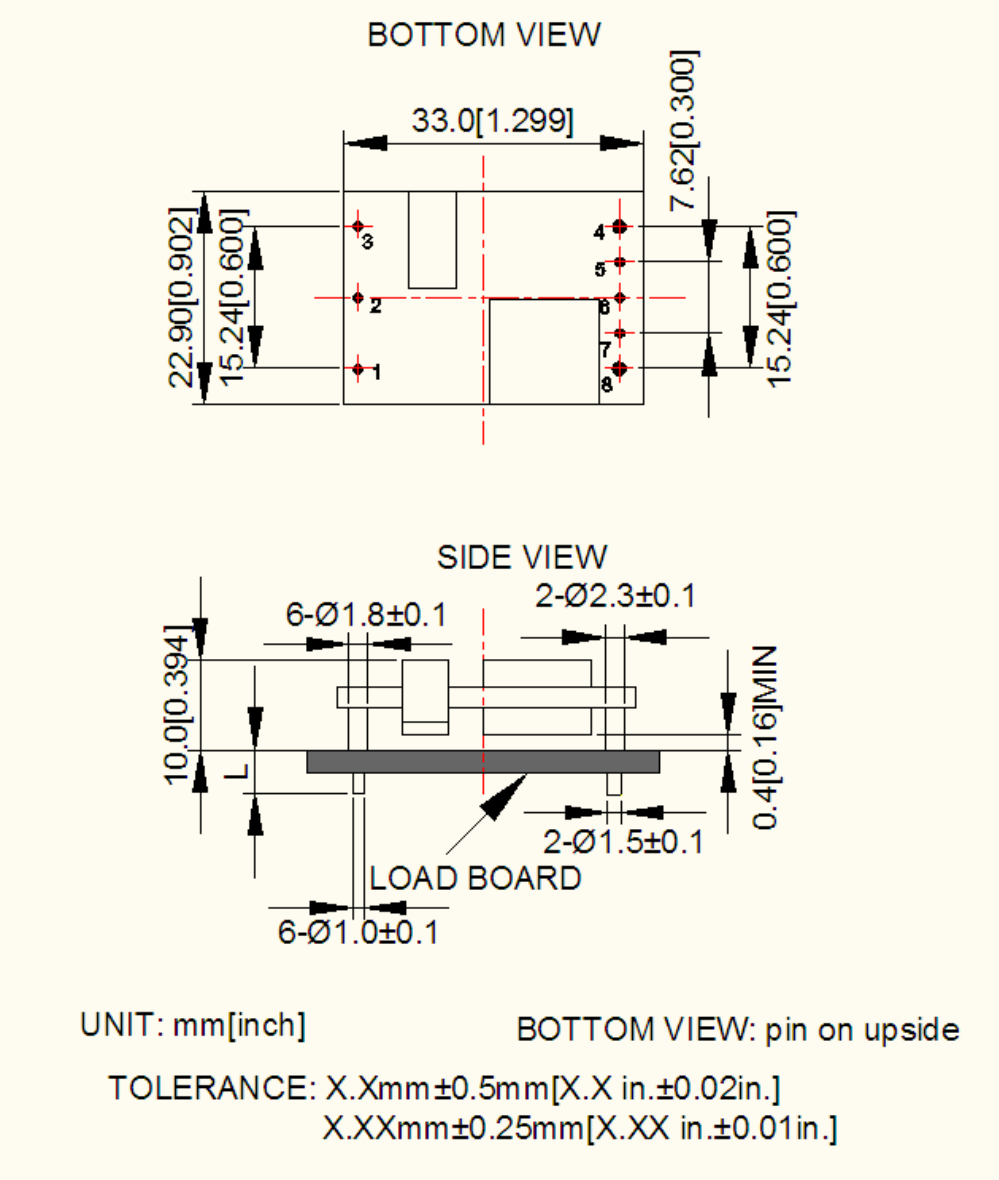

Figure 18 Output power derating, 48V<sub>in</sub>, air flowing across the converter from pin 3 to pin 1

### Mechanical Diagram



open Frame Module with SMT pin Mechanical diagram



open Frame Module Mechanical diagram

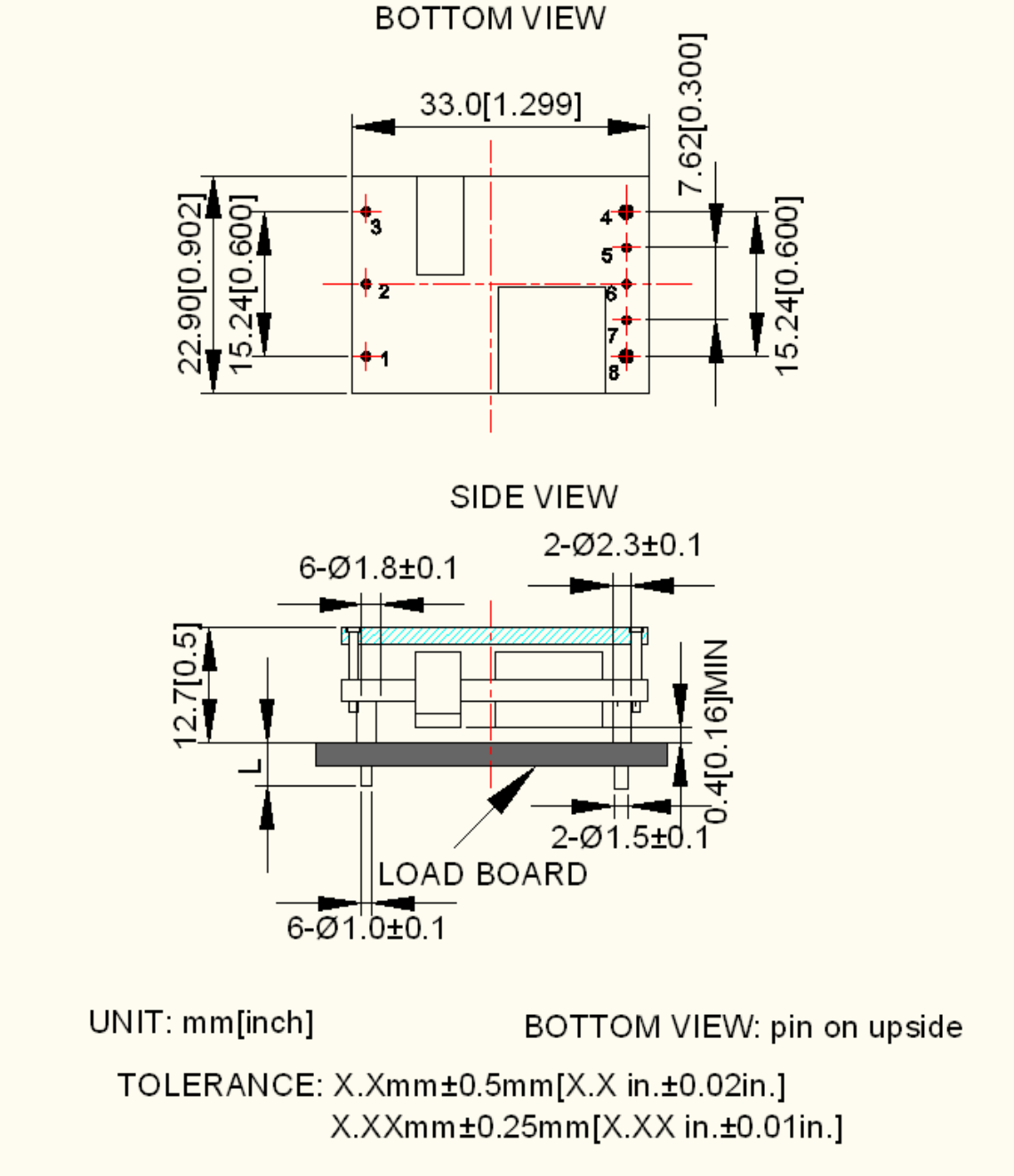

Mechanical diagram with base plate

Figure 19 Mechanical diagram

Pin length option

Device code suffix	L
-4	4.8mm±0.25mm
-6	3.8mm±0.25mm
-8	2.8mm±0.25mm
None	5.8mm±0.25mm

## Pin Designations

Pin NO.	Name	Function
1	Vin+	Positive input terminal
2	Remote ON/OFF	ON/OFF control terminal
3	Vin-	Negative input terminal
4	Vo-	Negative output terminal
5	Sense-	Negative remote sense
6	Trim	Output voltage trim
7	Sense+	Positive remote sense
8	Vo+	Positive output terminal

## Soldering

AVD85-48S3V3B-6L

The product is intended for standard manual or wave soldering.

When wave soldering is used, the temperature on pins is specified to maximum 260°C for maximum 7s.

When soldering by hand, the iron temperature should be maintained at 300°C ~ 380°C and applied to the converter pins for less than 10s. Longer exposure can cause internal damage to the converter.

Cleaning of solder joint can be performed with cleaning solvent IPA or simulative.

AVD85-48S3V3-6L , AVD85-48S3V3TL

The product is intended for standard manual, reflow or wave soldering.

When reflow soldering is used, the temperature on pins is specified to maximum 260°C for maximum 10s.

When wave soldering is used, the temperature on pins is specified to maximum 260°C for maximum 7s.

When soldering by hand, the iron temperature should be maintained at 300°C ~ 380°C and applied to the converter pins for less than 10s. Longer exposure can cause internal damage to the converter. Cleaning of solder joint can be performed with cleaning solvent IPA or simulative.

Assembly:

Package information:

- 1、 Package type: Moisture sensitivity level 3, Moisture Barrier Bags
- 2、 Minimal Package QTY: 192 PCS
- 3、 Package disassembly

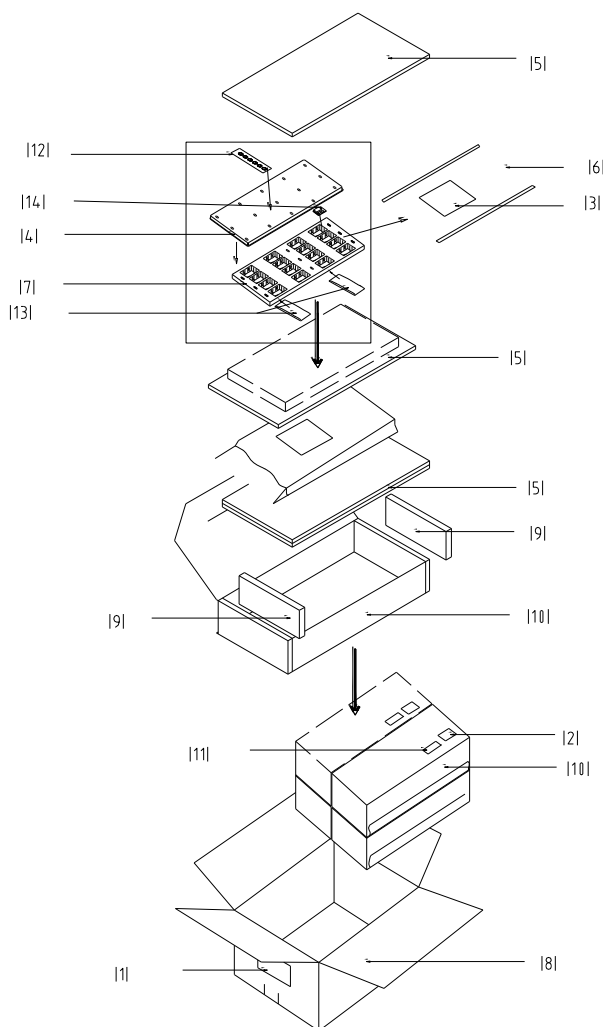

No.	Description
1	Shipping label
2	Moisture proof identification label
3	Moisture proof caution label
4	Tray cover
5	Anti-static Pe foam 1



- 6 Moisture barrier bag
- 7 Tray
- 8 Shipping carton
- 9 Anti-static Pe foam 2
- 10 Inner box
- 11 Model barcode label
- 12 Humidity indicating card
- 13 Desiccant
- 14 Model

4、 Package tray information

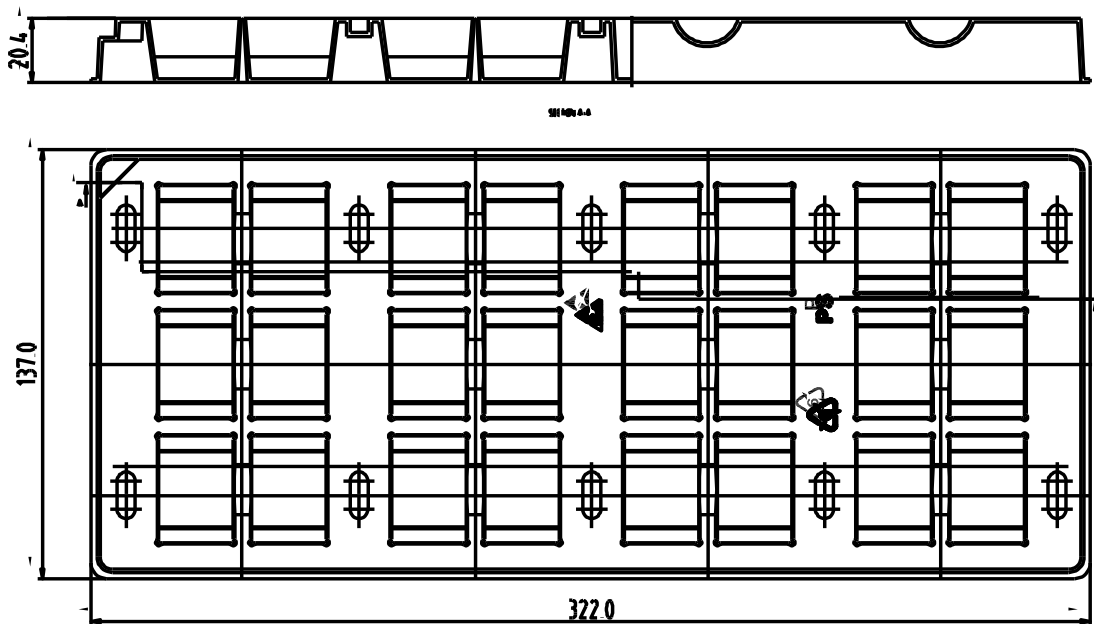

Ordering Information

<b>AVD85</b>	<b>-</b>	<b>48</b>	<b>S</b>	<b>3V3</b>	<b>P</b>	<b>B</b>	<b>-</b>	<b>6</b>	<b>L</b>
①		②	③	④	⑤	⑥		⑦	⑧

①	Model series	AVD: high efficiency sixteenth brick series, 85: output power 85W
②	Input voltage	48: 36V ~ 75V input range, rated input voltage 48V
③	Output number	S: single output
④	Rated output voltage	3V3: 3.3V output
⑤	Remote ON/OFF logic	Default: negative logic; P: positive logic
⑥	baseplated	B: with baseplate; default: open frame
⑦	Pin length	6: 3.8mm pin length T: SMT
⑧	RoHS status	Y: RoHS, R5; L: RoHS, R6

Model number	Description
AVD85-48S3V3-6L	3.8mm pin length; negative on/off logic; without thread inside mounting hole; R6 compliant
AVD85-48S3V3B-6L	3.8mm pin length; negative on/off logic; without thread inside mounting hole; R6 compliant;with case
AVD85-48S3V3TL	SMT pin; negative on/off logic; without thread inside mounting hole; R6 compliant

## Hazardous Substances Announcement (RoHS Of China)

Parts	Hardarzous Substances					
	Pb	Hg	Cd	Cr <sup>6+</sup>	PBB	PBDE
AVD85-48S3V3	x	x	x	x	x	x
<p>x: Means the content of the hazardous substances in all the average quality materials of the part is within the limits specified in SJ/T-11363-2006</p> <p>√: Means the content of the hazardous substances in at least one of the average quality materials of the part is outside the limits specified in SJ/T11363-2006</p> <p>Emerson Network Power Co., Ltd. has been committed to the design and manufacturing of environment-friendly products. It will reduce and eventually eliminate the hazardous substances in the products through unremitting efforts in research. However, limited by the current technical level, the following parts still contain hazardous substances due to the lack of reliable substitute or mature solution:</p> <ol style="list-style-type: none"> <li>1. Solders (including high-temperature solder in parts) contain plumbum.</li> <li>2. Glass of electric parts contains plumbum.</li> <li>3. Copper alloy of pins contains plumbum</li> </ol>						