

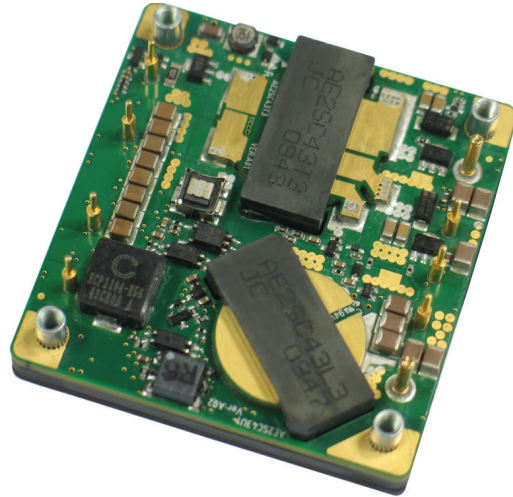

48Vdc Input, 12Vdc@50A Output Half-Brick Converter AVE600-48S12B-9LZ

Description

The AVE600-48S12B-9LZ is a single output DC-DC converter with standard half-brick outline and pin configuration. It delivers up to 50A output current with 12V output voltage. The converter can provide ultra-high efficiency of 95.6% and excellent thermal performance, which make it an ideal choice for bus converter. For typical applications, a heatsink and sufficient airflow are required.



Operational Features

- Up to 50A output current
- Industry standard half-brick foot print
- Basic isolation
- Ultra-high efficiency: 95.6% at 12V half load ($V_{in} = 48Vdc$)
- Improved thermal performance
- High power density
- Low output noise
- No minimum load requirement
- Wide input voltage of 36V~75V
- RoHS compliant

Control Features

- Remote control function (negative or positive logic optional)
- Remote output sense
- Trim function: 90% ~ 110%

Protection Features

- Input under-voltage lockout
- Output over-current protection
- Output over-voltage protection
- Over-temperature protection

Mechanical Features

- Industry standard half-brick pin-out outline
- Choice of short pins or long pins
- Pin length option: 4.0mm

Safety & EMC

- Meets safety standards UL 60950-1, CSA-C22.2 NO. 60950-1, IEC/EN 60950-1 and GB4943
- Approved by UL and TUV
- Meets 2006/95/EEC and 93/68/EEC directives which facilitates CE marking in user's end product
- Meets conducted emission's requirements of EN55022 Class B with external filter

Electrical Characteristics

Full operating ambient temperature range is -40°C to +85°C.

Specifications are subject to change without notice.

Parameter		Min.	Typ.	Max.	Unit	Notes & conditions
Absolute max. ratings						
Input voltage	Non-operating			100	V	100ms
	Operating			80	V	Continuous
Operating temperature		-40		+85	°C	Refer to <i>Thermal Considerations</i>
Storage temperature		-55		+125	°C	
Voltage at remote ON/OFF pin		-0.3		15	V	
Input characteristics						
Operating input voltage range		36	48	75	V	
Input under-voltage lockout	Turn-on voltage threshold		35	36	V	
	Turn-off voltage threshold	32	34		V	
	Lockout voltage hysteresis	1		3	V	
Max. input current				24	A	36V _{in} , full load
No-load input current				0.2	A	48V _{in} , full load
Standby input current			0.08	0.1	A	Remote OFF
Input reflected ripple current			50	150	mA	Through 12µH inductor; Figure 3
Recommended input fuse				30	A	External fast blow fuse is recommended; Figure 11
Input filter component values (C/L)			17.6/0.56		µF/µH	Internal values
Recommended external input capacitance			470		µF	Low ESR capacitor is recommended; Figure 11
Output characteristics						
Output voltage set point (standard option)		11.80	12	12.20	V	48V _{in} , full load
Output voltage line regulation			0.15	0.33	%	
			18	40	mV	
Output voltage load regulation			0.1	0.2	%	
			12	24	mV	
Output voltage temperature regulation				0.02	%/°C	

Parameter		Min.	Typ.	Max.	Unit	Notes & conditions
Total output voltage range		11.70	12	12.30	V	Over sample, line, load, temperature & life
Output voltage ripple and noise			100	200	mVpp	Figure 2 20MHz bandwidth; Figure 17
Operating output current range		0		50	A	
Output DC current-limit inception		52.5		65	A	Hiccup: auto-restart when over-current condition is removed
Output capacitance		680	2200	10000	μF	High frequency and low ESR are recommended
Dynamic characteristics						
Dynamic response	50% ~ 75% ~ 50% $I_{o,max}$, 0.1A/μs		250		mV	Figure 4 Test condition: 25°C, nominal input voltage, Figure 11
	Setting time		110		μs	Recovery to within 1% $V_{o,nom}$
	50% ~ 75% ~ 50% $I_{o,max}$, 1A/μs		400		mV	Figure 5 Test condition: 25°C, nominal input voltage, Figure 11
	Setting time		100		μs	Recovery to within 1% $V_{o,nom}$
Turn-on transient	Rise time		40	100	ms	Full load, Figure 6
	Turn-on delay time		120	150	ms	
	Output voltage overshoot		0	1	% V_o	
Efficiency						
100% load			94.8		%	Figure 1
50% load			95.6		%	Figure 1

Electrical Characteristics (Continued)

Parameter	Min.	Typ.	Max.	Unit	Notes & conditions	
Isolation characteristics						
Isolation voltage (conditions: 1mA for 60s, slew rate of 1500V/10s)	1500			V	Basic insulation, pollution degree 2, input to output	
	1500			V	Basic insulation, pollution degree 2, input to baseplate	
	500			V	Functional insulation, pollution degree 2, output to baseplate	
EMC characteristics						
ESD		B			IEC/EN61000-4-2 Level 3	
EFT ^[1]		B			IEC/EN61000-4-4 Level 3	
Surges ^[1]		B			IEC/EN61000-4-5 Line to ground (earth): 600V Line to line: 600V	
Conducted disturbances immunity		A			IEC/EN61000-4-6 Level 2	
DC voltage dips, short interruption, variation		B			EN61000-4-29	
Conducted emission					EN55022, DC input, Class B	
Feature characteristics						
Switching frequency	130	140	150	kHz		
Remote ON/OFF control (positive logic)	Off-state voltage	-0.7		1.2	V	Figure 13
	On-state voltage	3.5		12	V	
Remote ON/OFF control (negative logic)	Off-state voltage	3.5		12	V	
	On-state voltage	-0.7		1.2	V	
Output voltage trim range	10.8		13.2	V	See <i>Trim Characteristics</i> of <i>Application Note</i>	
Output voltage remote sense range			0.6	V		
Output over-voltage protection	14		17	V	Hiccup: auto-restart when over-voltage condition is removed	

Parameter	Min.	Typ.	Max.	Unit	Notes & conditions
Over-temperature shutdown		120		°C	Auto recovery; OTP test point on C86, Figure 10; Tested under thermal balance condition.
Over-temperature hysteresis		10		°C	
Reliability characteristics					
Calculated MTBF (telcordia)		1.5		10 ⁶ h	Telcordia SR-332-2006; 80% load, 300LFM, 40°C T _a

Note 1:

Criterion A: Normal performance during and after test.

Criterion B: Normal performance after test, automatic restart is allowed after test.

For EFT and surges, system reset is no allowed.

Criterion C: Normal performance after test, the module can be restarted manually after test.

Normal performance means that output noise (Vpp) meets the requirement of the specifications.

Qualification Testing

Parameter	Unit (pcs)	Test condition
Halt test	4 ~ 5	T _{a,min} -10°C to T _{a,max} +10°C, 5°C step, V _{in} = min to max, 0 ~ 105% load
Vibration	3	Frequency range: 5Hz ~ 20Hz, 20Hz ~ 200Hz, A.S.D: 1.0m ² /s ³ , -3db/oct, axes of vibration: X/Y/Z Time: 30 min/axis
Mechanical shock	3	30g, 6ms, 3 axes, 6 directions, 3 time/direction
Thermal shock	3	-40°C to +100°C, unit temperature 20 cycles
Thermal cycling	3	-40°C to +55°C, temperature change rate: 1°C/min, cycle: 2 cycles
Humidity	3	40°C, 95%RH, 48h
Solder ability	15	IPC J-STD-002C-2007

Characteristic Curves

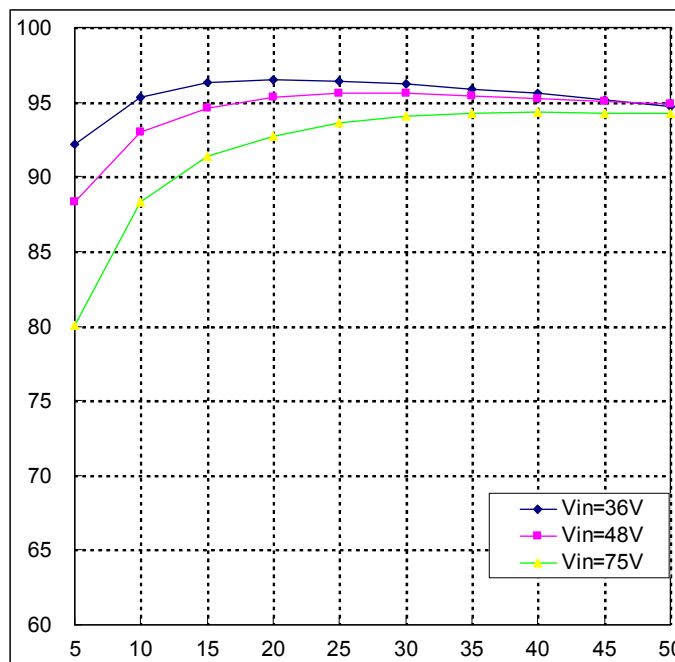

Figure 1 Efficiency and output current, $T_a = 25^\circ\text{C}$, $V_o = 12\text{V}$

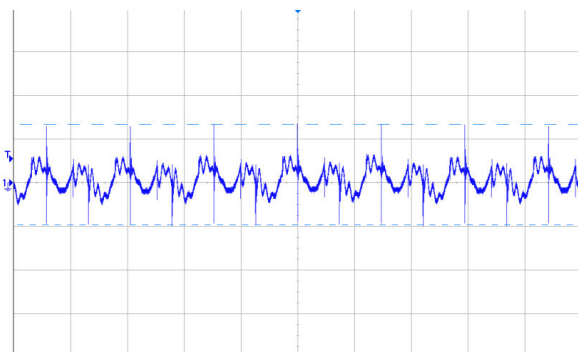

Figure 2 Output ripple & noise (2 $\mu\text{s}/\text{div}$, 20mV/div), see Figure 17 for test configuration

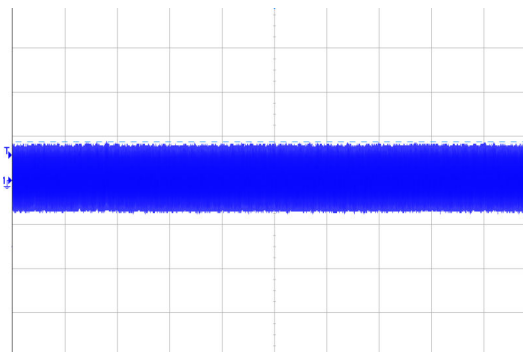

Figure 3 Input reflected ripple current (100ms/div, 50mA/div), see Figure 17 for test configuration

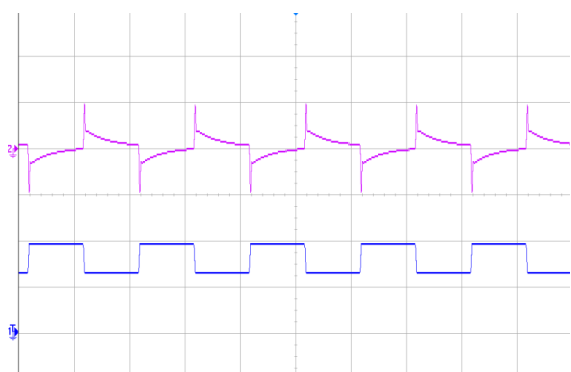

Figure 4 Dynamic response for 25% load step (50% ~ 75% ~ 50%) and 0.1A/ μs slew rate, (5ms/div), see Figure 11 for test configuration; CH2-output voltage (200mV/div); CH1-output current (20A/div)

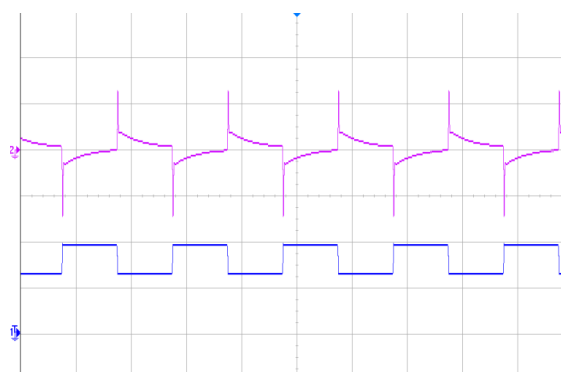

Figure 5 Dynamic response for 25% load step (50% ~ 75% ~ 50%) and 1A/ μs slew rate, (5ms/div), see Figure 11 for test configuration; CH2-output voltage (200mV/div); CH1-output current (20A/div)

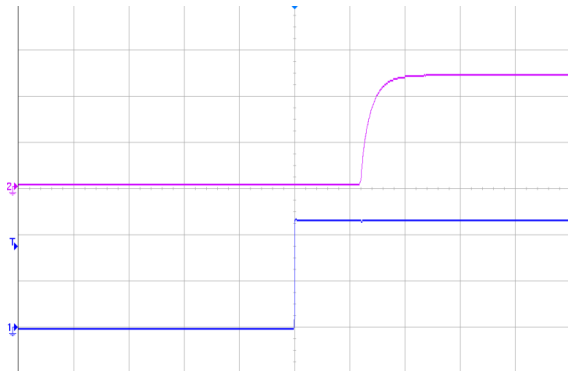

Figure 6 Output voltage startup by power-on, (100ms/div), see Figure 11 for test configuration; CH2-output voltage (5V/div); CH1-input voltage (20V/div)

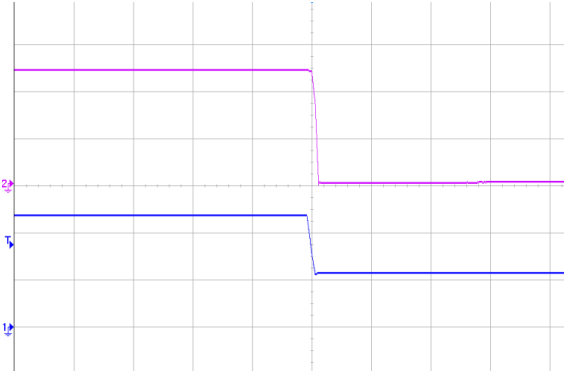

Figure 7 Output voltage shutdown by power-off, (5ms/div), see Figure 11 for test configuration; CH2-output voltage (5V/div); CH1-input voltage (20V/div)

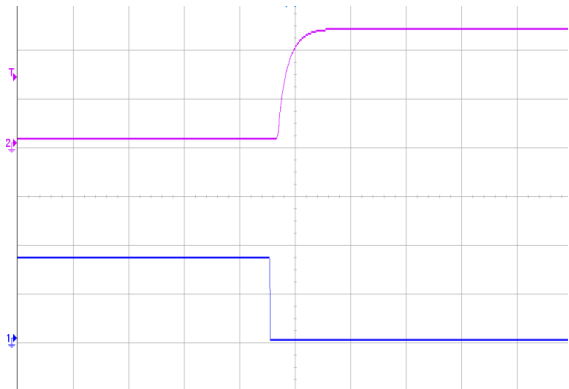

Figure 8 Output voltage startup by remote ON, (100ms/div), see Figure 11 for test configuration; CH2-output voltage (5V/div); CH1-remote ON voltage (2V/div)

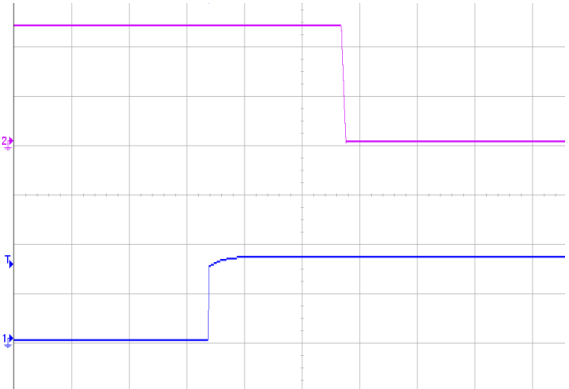

Figure 9 Output voltage shutdown by remote OFF, (5ms/div), see Figure 11 for test configuration; CH2-output voltage (5V/div); CH1-remote OFF voltage (2V/div)

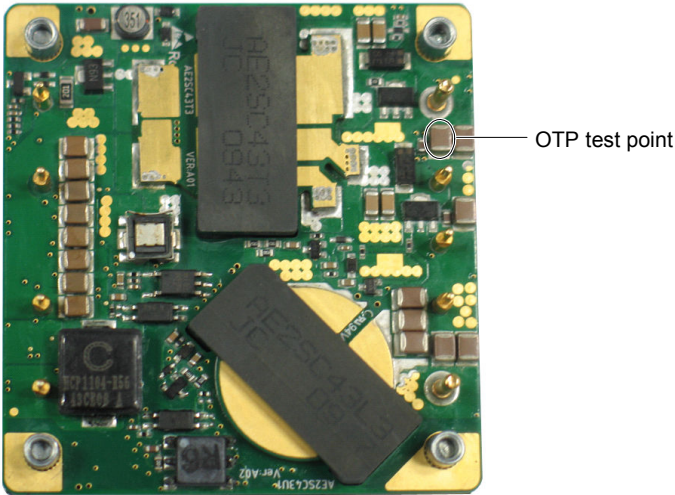

Figure 10 OTP test point

Application Note

Typical Application

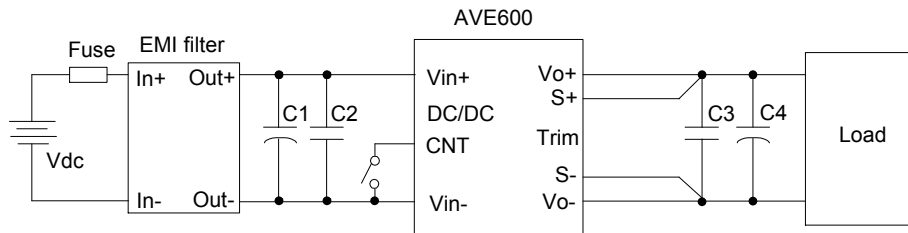

Figure 11 Typical application

C1: 470 μ F/100V electrolytic capacitor, P/N: UPM2A101MHD (Nichicon) or equivalent caps

C2, C3: 1 μ F/100V X7R ceramic capacitor, P/N: C3225X7R2A105KT0L0U (TDK) or equivalent caps

C4: 2200 μ F electrolytic capacitor, P/N: UPM1E102MHP (Nichicon) or equivalent caps

Note: The converter cannot be used in parallel mode directly!

Fuse: External fast blow fuse with a rating of 30A. The recommended fuse model is 314030P from LITTLEFUSE.

Remote ON/OFF

The converter is equipped with a primary ON/OFF (CNT) pin used to remotely turn the converter on or off via a system signal. Two CNT logic options are available. For the positive logic model a system logic low signal will turn the converter off. For the negative logic model a system logic high signal will turn the converter off. For negative logic models where no control signal will be used the ON/OFF pin should be connected directly to V_{in-} to ensure proper operation. For positive logic models where no control signal will be used, the ON/OFF pin should be left unconnected. Below is the detailed internal circuit and reference in AVE600-48S12B-9LZ.

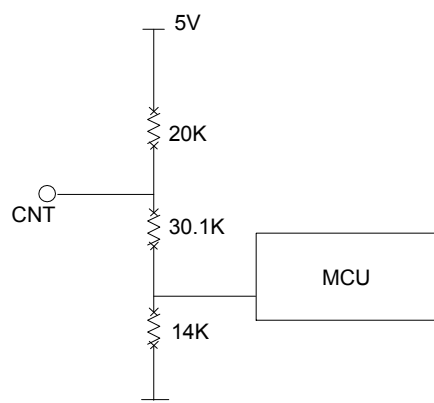

Figure 12 Remote ON/OFF internal diagram

The voltage between pin remote ON/OFF and pin V_{in-} must not exceed the range listed in table 'Feature characteristics' to ensure proper operation. The external remote ON/OFF circuit is highly recommended as shown in Figure 13.

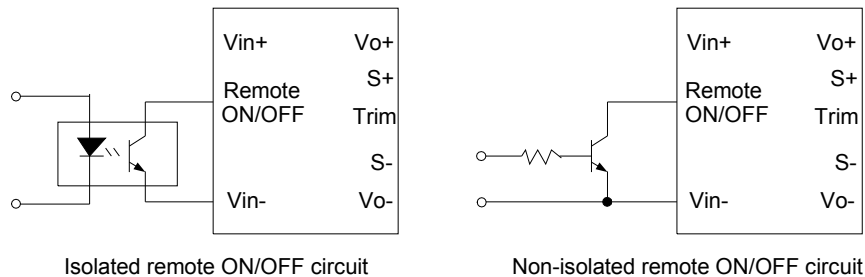

Figure 13 External remote ON/OFF circuit

Trim Characteristics

Connecting an external resistor between Trim pin and V_{o-} pin will decrease the output voltage, while connecting it between Trim and V_{o+} will increase the output voltage. The following equations determine the external resistance to obtain the trimmed output voltage.

$$R_{\text{trim-down}} = \left(\frac{100\%}{\Delta\%} - 2 \right) k\Omega$$

$$R_{\text{trim-up}} = \left(\frac{V_{\text{nominal}} (100\% + \Delta\%)}{1.225\Delta\%} - \frac{100\%}{\Delta\%} - 2 \right) k\Omega$$

$$\Delta\% = \left| \frac{V_{\text{nominal}} - V_{\text{desired}}}{V_{\text{nominal}}} \right| \times 100\%$$

V_{norm} : Nominal output voltage.

For example, to get 13.2V output, the trimming resistor is

$$R_{\text{trim-up}} = \left(\frac{13.2}{1.225 \times (13.2 - 12) / 12} - \frac{100\%}{(13.2 - 12) / 12} - 2 \right) = 95.75 k\Omega$$

The output voltage can also be trimmed by potential applied at the Trim pin.

$$V_o = (V_{\text{trim}} + 1.225) \times 4.898$$

Where V_{trim} is the potential that applied at the Trim pin, and V_o is the desired output voltage.

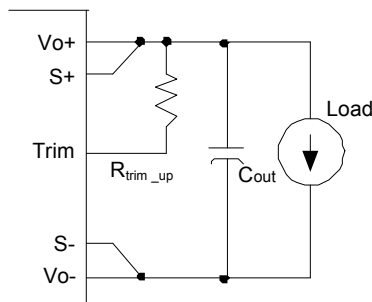

Figure 14 Trim up

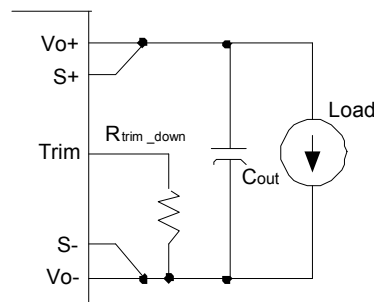

Figure 15 Trim down

When trimming up, the output current should be decreased accordingly so as not to exceed the maximum output power and the minimum input voltage should be increased as shown in Figure16.

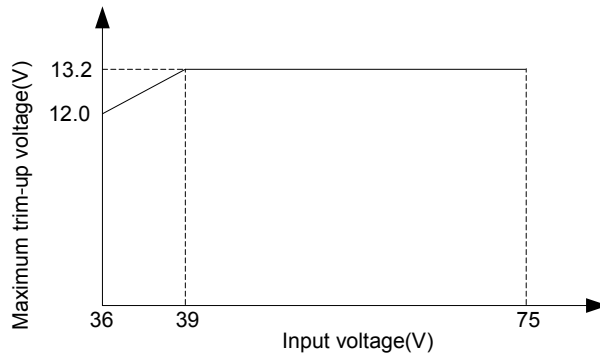

Figure 16 Maximum trim-up voltage and input voltage

Sense Characteristics

If the load is far from the unit, connect S+ and S- to the terminals of the load respectively to compensate the voltage drop on the transmission line. See Figure 11.

If the sense compensation function is not necessary, connect S+ to V_{o+} and S- to V_{o-} directly.

Input Ripple & Inrush Current And Output Ripple & Noise Test Configuration

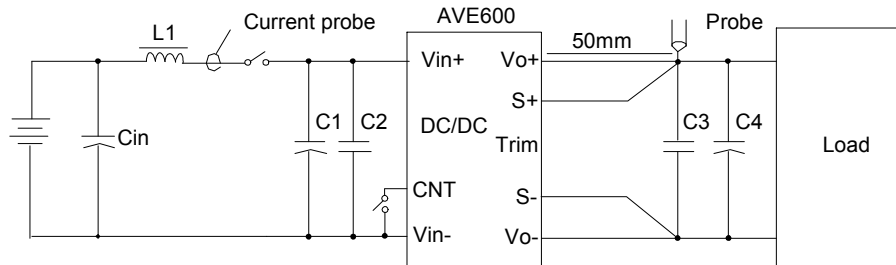

Figure 17 Input ripple & inrush current, output ripple & noise test configuration

Vdc: DC power supply

L1: 12μH

Cin: 220μF/100V typical

C1 ~ C4: See Figure 11

Note: It is recommended to use a coaxial cable with series 50Ω resistor and 0.68μF ceramic capacitor or a ground ring of probe to test output ripple & noise.

EMC Filter Configuration

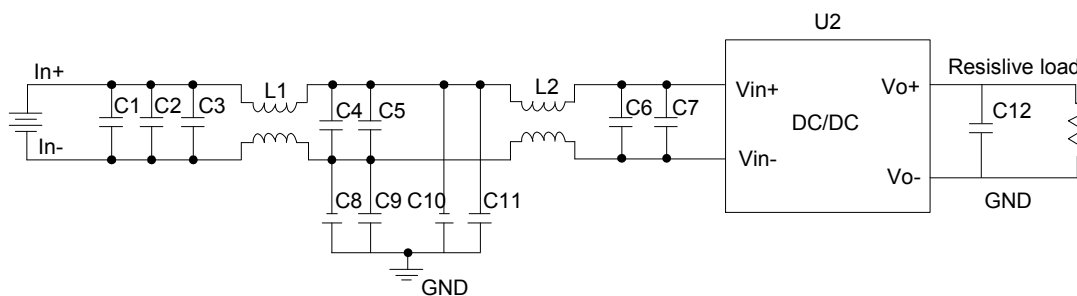

Figure 18 EMC test configuration

C1~C5: SMD ceramic capacitor-100V-1000nF-X7R-1210

C6: SMD ceramic capacitor-100V-100nF-±10%-X7R-1206

L1, L2: Common mode inductor-single phase-473μH-±25%-14A magnetic ring 1*25.4*12.7mm-working temperature range includes module temperature rise. Temperature rise at rated current: 55°C maximum

C8 ~ C11: High-voltage chip ceramic capacitor. Capacitance: 0.1U/630V/X7R. Size: 2220. Capable of withstanding 1kV voltage

C7: Input electrolytic capacitor, according to the same type as C1 in Figure 11

C12: Output electrolytic capacitor, according to the same type as C4 in Figure 11

U2: Module to test, AVE600-48S12B-9LZ

PE: Connected to output

Baseplate: Be not connected

Thermal Considerations

The converter is designed to operate in different thermal environments and sufficient cooling must be provided. Proper cooling of the DC-DC converter can be verified by measuring the temperature at the test points as shown in the Figure 19. The temperature at these points should not exceed the maximum values in Table 1.

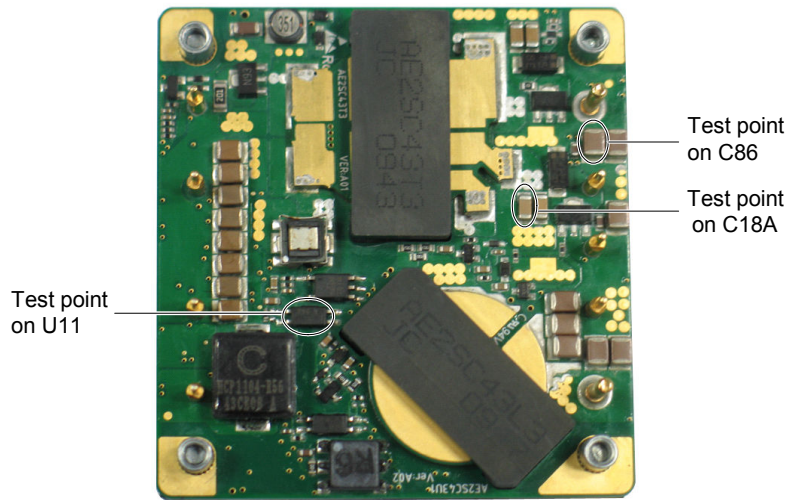

Figure 19 Temperature test points

Table 1 Temperature limit of the test points

Test point	Temperature limit
Test point on C86	116°C
Test point on U11	113°C
Test point on C18A	118°C

The converter can operate with a smaller heatsink and sufficient airflow. Figure 21 shows the derating output current vs. ambient air temperature at different air velocity with a specified heatsink.

The typical test condition is shown in Figure 20.

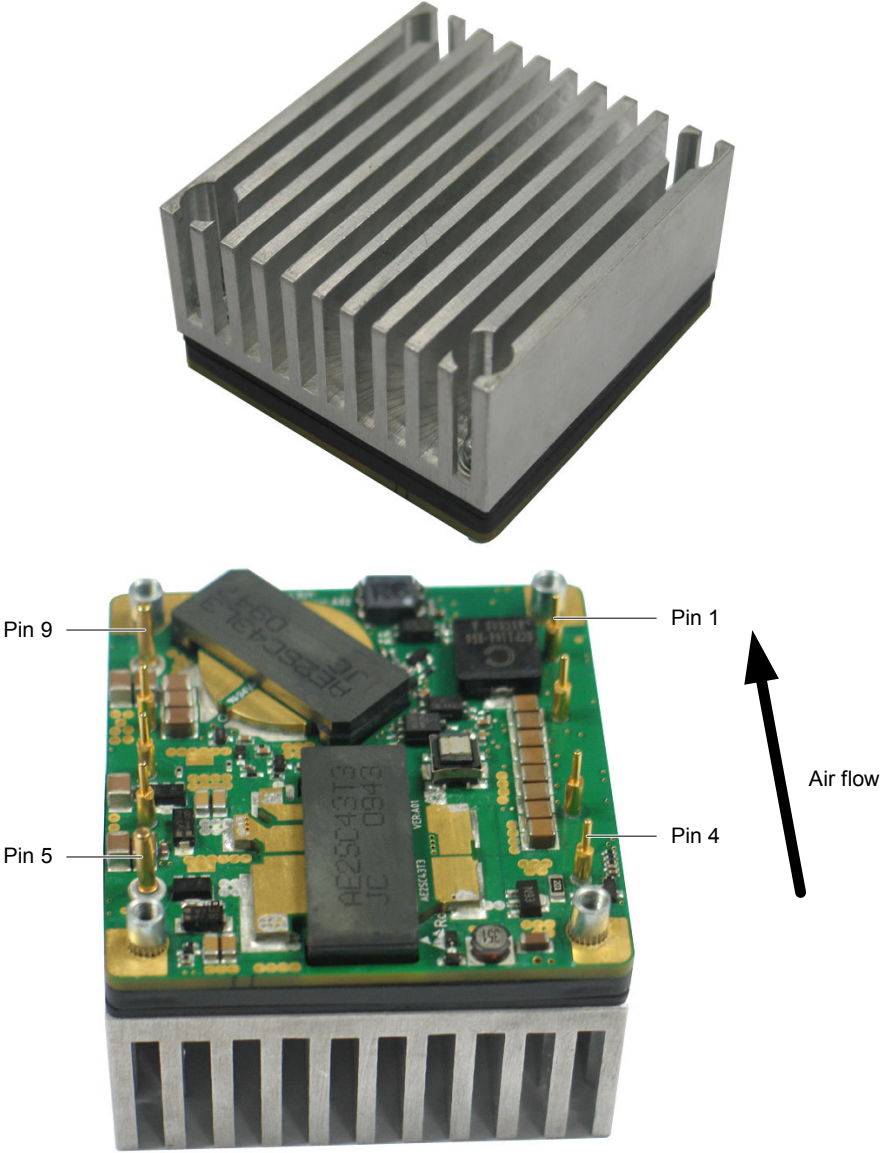

Figure 20 Typical test condition, heatsink size (L × W × H): 61mm × 58mm × 25.4mm

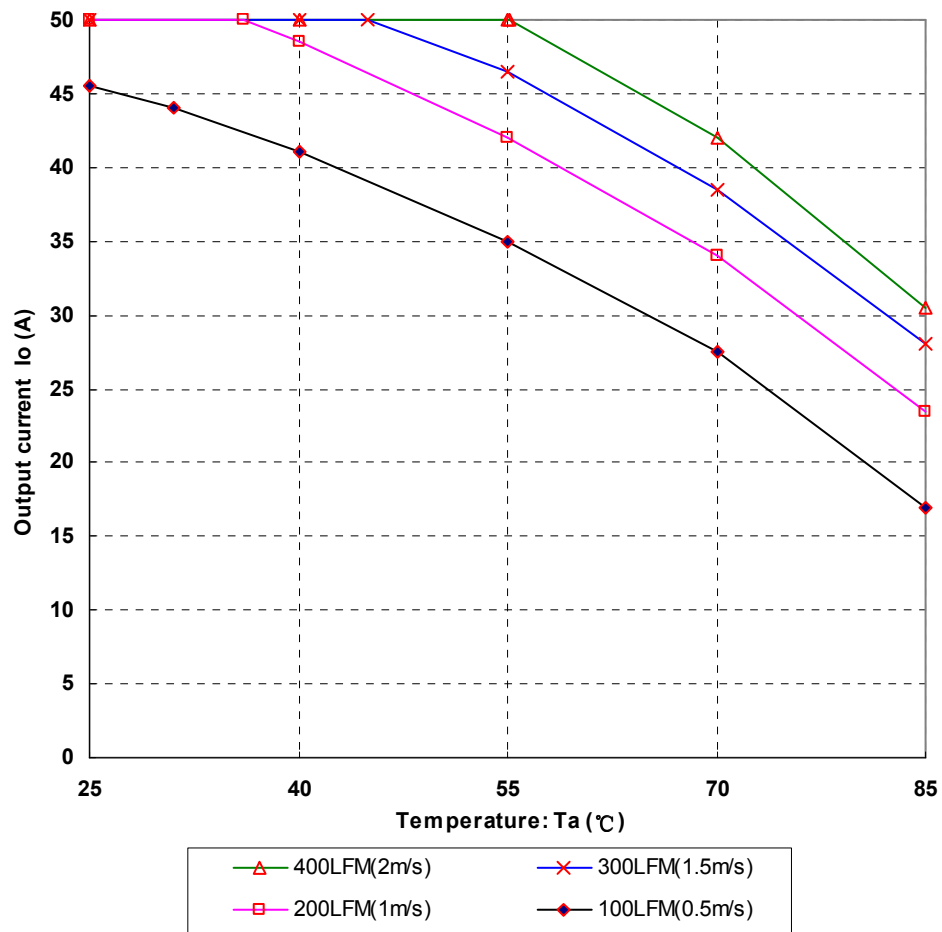
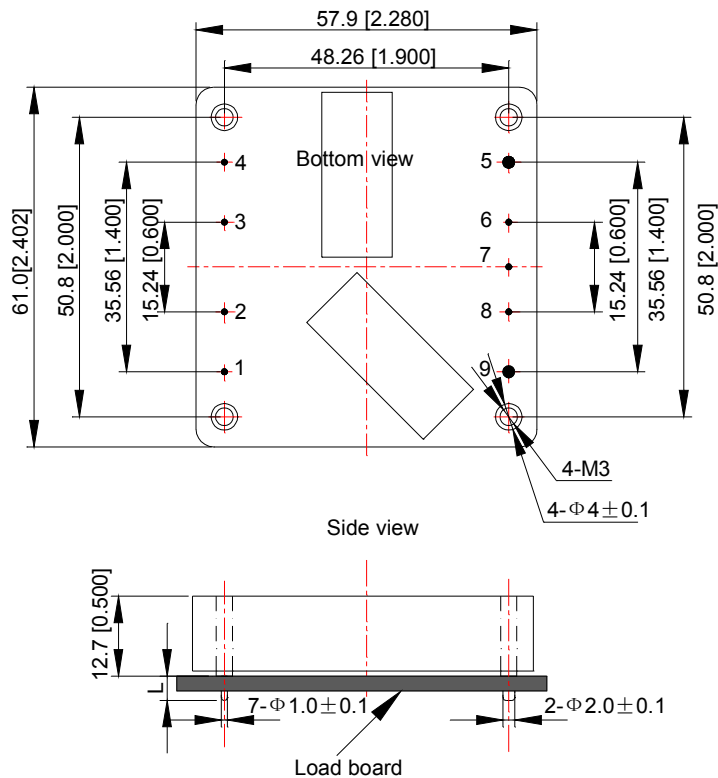

Figure 21 Output power derating, 48V_{in}, air flowing across the converter from pin 4 to pin 1

Mechanical Diagram



Unit: mm[inch] Bottom view: pin on upside
 Tolerance: X.Xmm ± 0.5mm[X.X in. ± 0.02in.]
 X.XXmm ± 0.25mm[X.XX in. ± 0.01in.]

Figure 22 Mechanical diagram

Pin length option

Device code suffix	L
-4	4.8mm ± 0.5mm
-6	3.8mm ± 0.5mm
-8	2.8mm ± 0.5mm
None	5.8mm ± 0.5mm

Pin Designations

Pin No.	Name	Function
1	V _{in+}	Positive input terminal
2	Remote ON/OFF	ON/OFF control terminal
3	Case	Pin connected to baseplate
4	V _{in-}	Negative input terminal
5	V _{o-}	Negative output terminal
6	Sense-	Negative remote sense
7	Trim	Output voltage trim
8	Sense+	Positive remote sense
9	V _{o+}	Positive output terminal

Soldering

The product is intended for standard manual, wave soldering.

When wave soldering is used, the temperature on pins is specified to maximum 260°C for maximum 7s.

When manual soldering is used, the iron temperature should be maintained at 300°C ~ 380°C and applied to the converter pins for less than 10s. Longer exposure can cause internal damage to the converter.

Cleaning of solder joint can be performed with cleaning solvent IPA or simulative.

Ordering Information

AVE600	-	48	S	12	P	B	-	4	L
①		②	③	④	⑤	⑥		⑦	⑧

①	Model series	AVE: high efficiency half brick series, 600: output power 600W
②	Input voltage	48: 36V ~ 75V input range, rated input voltage 48V
③	Output number	S: single output
④	Rated output voltage	12: 12V output
⑤	Remote ON/OFF logic	Default: negative; P: positive logic
⑥	Baseplate	With baseplate
⑦	Pin length	-4: 4.8mm ± 0.5mm
⑧	RoHS status	L: RoHS, R6; Y: RoHS, R5

Model number	Description
AVE600-48S12B-9LZ	4.0mm pin length; negative on/off logic; thread inside mounting hole; R6 compliant

Hazardous Substances Announcement (RoHS Of China)

Parts	Hazardous substances					
	Pb	Hg	Cd	Cr ⁶⁺	PBB	PBDE
AVE600-48S12B-9LZ	x	x	x	x	x	x

x: Means the content of the hazardous substances in all the average quality materials of the part is within the limits specified in SJ/T-11363-2006

√: Means the content of the hazardous substances in at least one of the average quality materials of the part is outside the limits specified in SJ/T11363-2006

ASTECCo., Ltd. has been committed to the design and manufacturing of environment-friendly products. It will reduce and eventually eliminate the hazardous substances in the products through unremitting efforts in research. However, limited by the current technical level, the following parts still contain hazardous substances due to the lack of reliable substitute or mature solution:

1. Solders (including high-temperature solder in parts) contain plumbum.
2. Glass of electric parts contains plumbum.
3. Copper alloy of pins contains plumbum