

AVE300-48S1V2 DC/DC Converter

Technical Reference Note

Industry Standard Half Brick: 36~75V Input, 1.2V single Output



Industry Standard Half Brick: 2.4"X 2.28" X 0.5"

Features

- **Delivers up to 60A output current**
- **Basic isolation**
- **Ultra High efficiency**
- **Improved thermal performance:**
- **High power density**
- **Low output noise**
- **2:1 wide input voltage of 36-75V**
- **CNT function**
- **Remote sense**
- **Trim function: +10%/-20%**
- **Input under-voltage lockout**
- **Output over-current protection**
- **Output over-voltage protection**
- **Over-temperature protection**
- **RoHS compliant**

Options

- Choice of positive logic or negative logic for CNT function
- Choice of short pins or long pins
- Choice of with baseplate or without baseplate

Description

The AVE300-48S1V2 is a new DC-DC converter for optimum efficiency and power density. AVE300-48S1V2 provides up to 60A output current in an industry standard Half Brick, which makes it an ideal choice for small space and high power applications. AVE300-48S1V2 uses an industry standard half brick 61.0mm × 57.9mm × 12.7mm (2.4"x2.28"x0.5"with baseplate) and 61.0mm × 57.9mm × 9.5mm (2.4"x2.28"x0.375"without baseplate), provides CNT and trim functions. AVE300-48S1V2 can provide 1.2V@60A, single output and output is isolated from input.

OPTIONS	1
DESCRIPTION.....	1
MODULE NUMBERING	4
ELECTRICAL SPECIFICATIONS	5
INPUT SPECIFICATIONS	5
ABSOLUTE MAXIMUM RATINGS.....	6
OUTPUT SPECIFICATIONS	7
OUTPUT SPECIFICATIONS (CONT).....	8
OUTPUT SPECIFICATIONS (CONT).....	8
FEATURE SPECIFICATIONS	9
CHARACTERISTIC CURVES	10
PERFORMANCE CURVES – STARTUP CHARACTERISTICS.....	11
FEATURE DESCRIPTION.....	12
CNT FUNCTION.....	12
TRIM.....	13
MINIMUM LOAD REQUIREMENTS.....	13
OUTPUT OVER-CURRENT PROTECTION	13
OUTPUT CAPACITANCE.....	14
DECOUPLING	14
GROUND LOOPS	14
OUTPUT OVER-VOLTAGE PROTECTION	15
OVER-TEMPERATURE PROTECTION.....	15
DESIGN CONSIDERATION	15
TYPICAL APPLICATION	15
FUSING	15
INPUT REVERSE VOLTAGE PROTECTION.....	15
EMC	16
SAFETY CONSIDERATION.....	17
THERMAL CONSIDERATION	17
TECHNOLOGIES	17
BASIC THERMAL MANAGEMENT.....	17
MODULE DERATING	18
<i>Experiment Setup</i>	18
<i>Convection Without Heatsinks</i>	18
<i>Heatsink Configuration</i>	19
<i>Heatsink Mounting</i>	19
INSTALLATION	20
SOLDERING	20

MECHANICAL CHART	21
ORDERING INFORMATION	22

Module Numbering

AVE 300 - 48 S 1V2 PB - 4

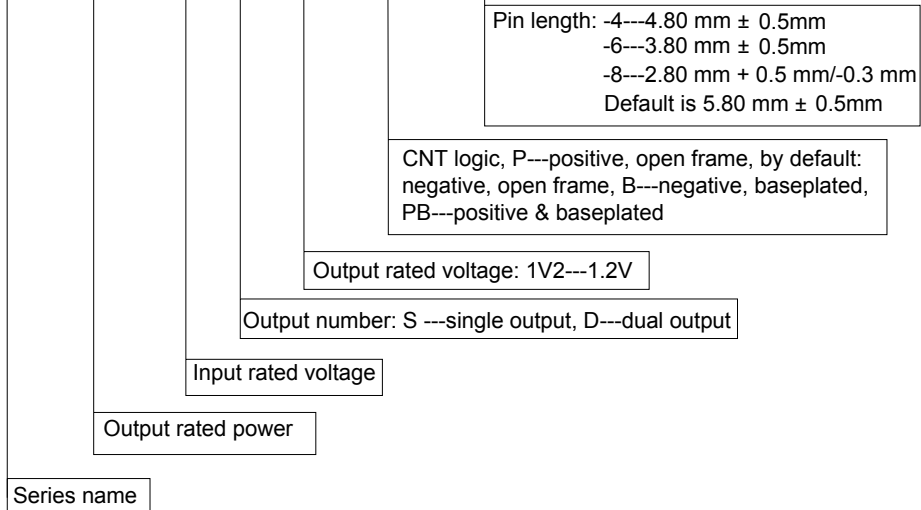

Electrical Specifications

Unless otherwise indicated, specifications apply over all operating input voltage and temperature conditions. Standard test condition on a single unit is as following:

Ta: 25°C
 +Vin: 48V ± 2%
 -Vin: return pin for +Vin
 CNT: connect to -Vin
 +Vout: connect to load
 -Vout: connect to load (return)
 +Sense: connect to +Vout
 -Sense: connect to -Vout
 Trim (Vadj): Open

Input Specifications

Parameter	Symbol	Min	Typ	Max	Unit	Note
Operating Input Voltage	V_i	36	48	75	V _{DC}	
Inrush transient	-	-	-	1	A ² s	-
Input Reflected-ripple Current	I_i	-	15	25	mAp-p	5Hz to 20MHz: 12μH source impedance, T _A = 25°C.
Supply voltage rejection (ac)	-	45	60	-	dB	120Hz

CAUTION: This power module is not internally fused. An input line fuse must always be used.

Absolute Maximum Ratings

Stresses in excess of the absolute maximum ratings can cause permanent damage to the device. These are absolute stress ratings only. Functional operation of the device is not implied at these or any other conditions in excess of those given in the operational sections of the IPS. Exposure to absolute maximum ratings for extended periods can adversely affect device reliability.

Parameter		Symbol	Min	Typ	Max	Unit	Note
Input Voltage	Continuous	VI	0	-	80	Vdc	
	Transient	VI, trans	0	-	100	Vdc	100ms
Operating Ambient Temperature		Ta	-40	25	55	°C	See Thermal Consideration
Operating Board Temperature without baseplate		Tc	105	-	120	°C	Near temperature sensor Rt
Operating Board Temperature With baseplate		Tc	100	-	115	°C	Center of baseplate
Storage Temperature		TSTG	-55	25	125	°C	
Operating Humidity		-	5	-	95	%	
Basic Input-Output Isolation(without baseplate)		-	1,500	-	-	Vdc	1mA for 5 sec, slew rate of 1,500V/10sec
Basic Input-Baseplate Isolation(with baseplate)		-	1,500	-	-	Vdc	1mA for 5 sec, slew rate of 1,500V/10sec
Basic Output-Baseplate Isolation(with baseplate)		-	500	-	-	Vdc	1mA for 5 sec, slew rate of 1,500V/10sec
Basic Input-Output Isolation(with baseplate)		-	1,500	-	-	Vdc	1mA for 5 sec, slew rate of 1,500V/10sec
Output Power		Po,max	-	-	72	W	

Output Specifications

Parameter		Symbol	Min	Typ	Max	Unit	Conditions
Output Ripple & Noise		-	-	50	75	mVp-p (f<20M Hz)	(Ta:25°C, Air velocity: 300LFM, Vin: 48V, Vonom, Ionom, 10u tantalum(ESR 100 m)// 1μ ceramic capacitor)
		-	-	75	100	mVp-p (f<20M Hz)	Whole range
External Load Capacitance		-	470	2200	10000	μF	(Ta:25°C, Vin: 48V, 30000μF can start-up)
Output Voltage Setpoint		Vo,set	1.18	1.2	1.22	Vdc	Rating input@ Ionom
Output Regulation	Line (Vi,min to Vi,max)	-	-	-	5	mv	Whole range
	Load (Io = Io,min to Io,max)	-	-	-	10	mv	
	Temperature Regulation (Whole range)	--	--	--	0.02	%Vo/°C	
Rated Output Current		Io	0	30	60	A	
Output Current-limit Inception (Hiccup)		Io	66	-	84	A	
Efficiency		-	84	86	-	%	Ta:25°C, Air velocity: 300LFM, Vin: 48V, Load: Ionom; forced air direction: from Vin+ to Vin-
Efficiency		-	86	88	-	%	Ta:25°C, Air velocity: 300LFM, Vin: 48V, Load: 50% Ionom; forced air direction: from Vin+ to Vin-

Output Specifications (Cont)

Parameter		Symbol	Min	Typ	Max	Unit	Note
Dynamic Response (all)	Peak Deviation:	-	-	-	100	mV	25% I _{onm} step from 50% I _{onm} , 0.1A/μS
	Settling Time (to V _{o,nom}):	-	-	-	500	μsec	
	Peak Deviation	-	-	-	150	mV	50% I _{onm} step from 50% I _{onm} , 0.1A/μS:
	Settling Time (to V _{o,nom})	-	-	-	-	μsec	
	Peak Deviation	-	-	-	200	mV	10% I _{onm} to 100% I _{onm} , 0.1A/μS
	Settling Time (to V _{o,nom})	-	-	-	-	μsec	

Output Specifications (Cont)

Parameter	Symbol	Min	Typ	Max	Unit	Note
Turn-On Time	-	-	-	20	msec	I _o = I _{onm} ; V _o from 10% to 90%
Output Voltage Overshoot	-	-	-	5	%V _o	I _o = I _{onm} ; T _A = 25°C
Switching Frequency	-	-	250	-	KHz	

Feature Specifications

Parameter		Symbol	Min	Typ	Max	Unit	Note
Enable pin voltage:	Logic Low		-0.7	-	1.2	Vdc	
	Logic High		3.5	-	12	Vdc	
Enable pin current:	Logic Low		-	-	1.0	mA	
	Logic High		-	-	-	μA	
Output Voltage Adjustment Range		-	80	-	110	%Vo	-
Output Over-voltage Protection (Static)		Voclamp	1.4	-	1.7	V	Hiccup
Output Over-voltage Protection (Dynamic)		Voclamp	1.4	-	2.0	V	Hiccup
Under-voltage Lockout	Turn-on Point	-	31	34	36	V	-
	Turn-off Point	-	30	33	35	V	
Isolation Capacitance		-	-	-	-	PF	
Isolation Resistance		-	10	-	-	MΩ	
Calculated MTBF		-	-	2,000,000	-	Hours	Vin: 48V, Load: Ionom Board@25°C
Weight		-	-	103	-	g(oz.)	With baseplate
		-	-	72	-	g(oz.)	Without baseplate
Vibration (Sine wave)		Vibration level: 3.5mm (2 ~ 9Hz), 10m/s ² (9 ~ 200HZ), 15m/s ² (200 ~ 500HZ) Directions and time: 3 axis (X, Y, Z), 30 minutes each Sweep velocity: 1oct / min					
Shock (Half-sine wave)		Peak acceleration: 300m/s ² Duration time: 6ms Continuous shock 3 times at each of 6 directions (± X, ± Y, ± Z)					

Characteristic Curves

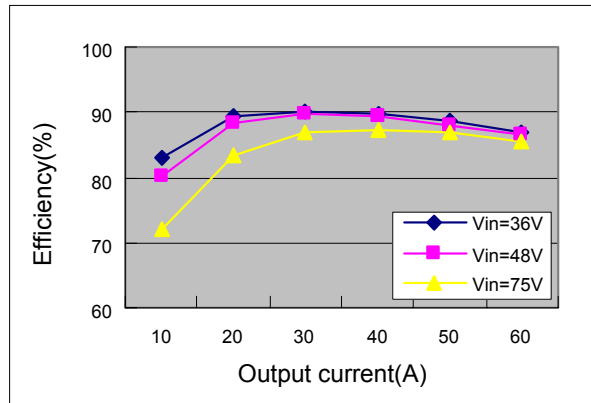

Fig.1 AVE300-48S1V2 Typical Efficiency

Ta:25°C, Air velocity : 300LFM, Vin: 48V, Load: Ionom; forced air direction: from Vin+ to Vin-.

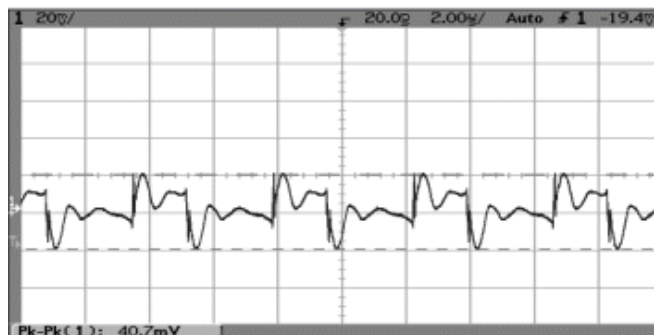

Fig.2 AVE300-48S1V2-4 Typical Output Ripple Voltage

Ta:25°C, Air velocity: 300LFM, Vin: 48V, Vonom, Ionom, 10μ tantalum(ESR 100 mΩ) // 1μ ceramic capacitor

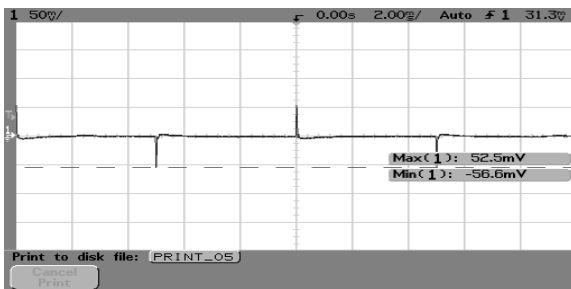

Fig3 AVE300-48S1V2-4 Typical Transient Response to Ta:25 , Air velocity: 300LFM, forced air direction: from Vin+ to Vin-. Vin: 48V, Vonom, 25% Ionom step from 50% Ionom, 0.1A/μs , the external capacitor should be “10μ tantalum(ESR 100 mΩ) // 1μ ceramic capacitor.

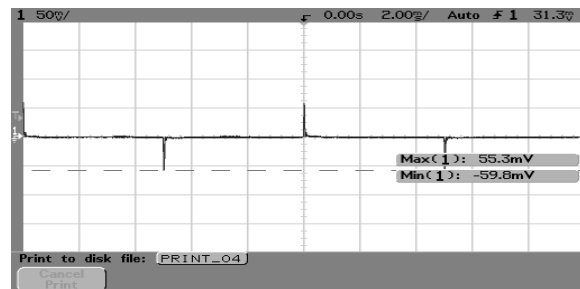

Fig4 AVE300-48S1V2-4. Typical Transient Response to Ta:25 , Air velocity: 300LFM, forced air direction: from Vin+ to Vin-. Vin: 48V, Vonom, 50% Ionom step from 75% Ionom, 0.1A/μs , the external capacitor should be “10μ tantalum(ESR 100 mΩ) // 1μ ceramic capacitor.

Performance Curves – Startup Characteristics

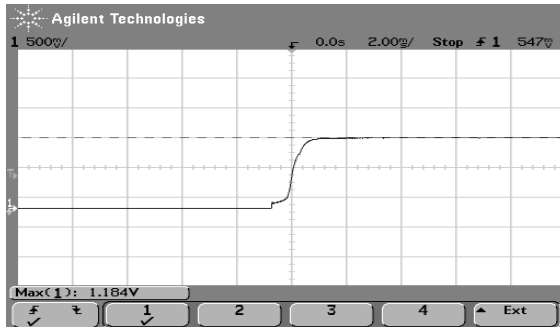

Fig.5 Typical start-up from power on

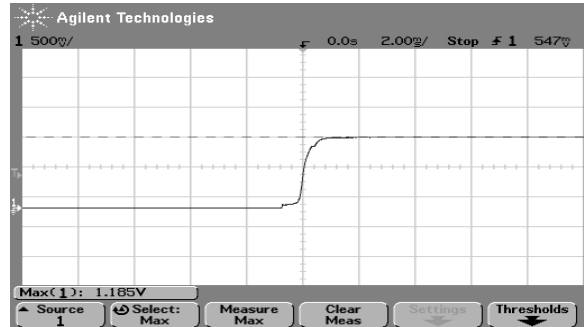

Fig.6 Typical start-up from CNT on

Feature Description

CNT Function

Two CNT logic options are available. The CNT logic, CNT voltage and the module working state are as the following table.

	L	H	OPEN
N	ON	OFF	OFF
P	OFF	ON	ON

N--- means "Negative Logic"

P--- means "Positive Logic"

L--- means "Low Voltage", -0.7V L 1.2V

H--- means "High Voltage", 3.5V H 12V

ON--- means "Module is on", OFF--- means "Module is off"

Open--- means "CNT pin is left open"

Note: when CNT is left open, V_{CNT} may reach 6V.

Figure 7 shows a few simple CNT circuits.

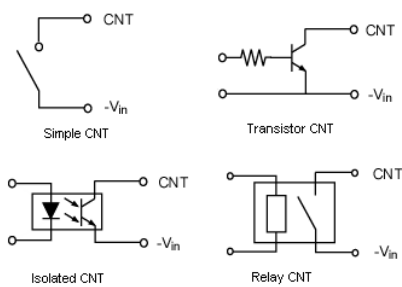

Fig.7 CNT circuits

Remote Sense

AVE300-48S1V2 converter can remotely sense both lines of its output which moves the effective output voltage regulation point from the output terminals of the unit to the point of connection of the remote sense pins. This feature automatically adjusts the real output voltage of AVE300-48S1V2 in order to

compensate for voltage drops in distribution and maintain a regulated voltage at the point of load.

When the converter is supporting loads far away, or is used with undersized cabling, significant voltage drop can occur at the load. The best defense against such drops is to locate the load close to the converter and to ensure adequately sized cabling is used. When this is not possible, the converter can compensate for a drop of up to 10% V_o , through use of the sense leads.

When used, the + Sense and - Sense leads should be connected from the converter to the point of load as shown in Figure 8, using twisted pair wire, or parallel pattern to reduce noise effect. The converter will then regulate its output voltage at the point where the leads are connected. Care should be taken not to reverse the sense leads. If reversed, the converter will trigger OVP protection and turn off. When not used, the +Sense lead must be connected with + V_o , and -Sense with - V_o . Although the output voltage can be increased by both the remote sense and trim, the maximum increase for the output voltage is not the sum of both.

The maximum increase is the larger of either the remote sense or the trim.

Note that at elevated output voltages the maximum power rating of the module remains the same, and the output current capability will decrease correspondingly.

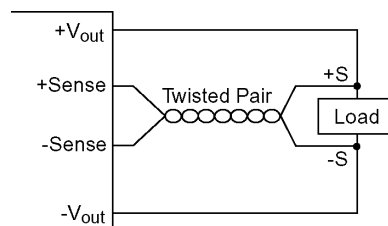

Figure 8 Sense connection

Trim

The +Vo output voltage of AVE300-48S1V2 can be trimmed using the trim pin provided. Applying a resistor to the trim pin through a voltage divider from the output will cause the +Vo output to increase by up to 10% or decrease by up to 20%. Trimming up by more than 10% of the nominal output may activate the OVP circuit or damage the converter. Trimming down more than 20% can cause the converter to regulate improperly. If the trim pin is not needed, it should be left open.

Trim up

With an external resistor connected between the TRIM and +SENSE pins, the output voltage set point increases (see Figure 9).

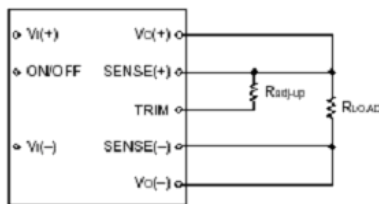

Figure 9 Trim up circuit

The following equation determines the required external-resistor value to obtain a percentage output voltage change of %.

$$R_{adj-up} = \frac{V_o(100+y)}{0.6 \cdot y} - \frac{(100+2y)}{y}$$

Note: y is the adjusting percentage of the voltage. $0 < y < 10$. Radj-up is in kΩ.

Trim down

With an external resistor between the TRIM and -SENSE pins, the output voltage set point decreases (see Figure 10).

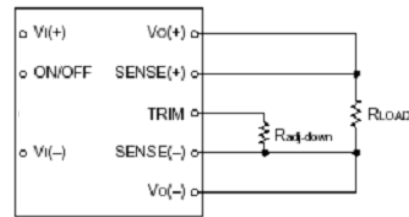

Figure 10 Trim down circuit

The following equation determines the required external-resistor value to obtain a percentage output voltage change of %.

$$R_{adj-down} = \frac{100}{y} - 2$$

Note: y is the adjusting percentage of the voltage. $0 < y < 10$. Radj-up is in kΩ.

Although the output voltage can be increased by both the remote sense and by the trim, the maximum increase for the output voltage is not the sum of both. The maximum increase is the larger of either the remote sense or the trim.

Note that at elevated output voltages the maximum power rating of the module remains the same, and the output current capability will decrease correspondingly.

Minimum Load Requirements

There is no minimum load requirement for the AVE300-48S1V2 module.

Parameter	Device	Symbol	Typ	Unit
Minimum Load	1.2V	I_{MIN}	0	A

Output Over-current Protection

AVE300-48S1V2 DC/DC converter feature foldback current limiting as part of their Over-current Protection (OCP) circuits. When output current exceeds 110 to 140% of rated current, such as during a short circuit condition,

the module will work on intermittent mode, also can tolerate short circuit conditions indefinitely. When the over-current condition is removed, the converter will automatically restart.

Output Capacitance

High output current transient rate of change (high di/dt) loads may require high values of output capacitance to supply the instantaneous energy requirement to the load. To minimize the output voltage transient drop during this transient, low Equivalent Series Resistance (ESR) capacitors may be required, since a high ESR will produce a correspondingly higher voltage drop during the current transient.

When the load is sensitive to ripple and noise, an output filter can be added to minimize the effects. A simple output filter to reduce output ripple and noise can be made by connecting a capacitor C_1 across the output as shown in Figure 11. The recommended value for the output capacitor C_1 is $2200\mu F$.

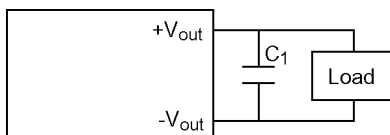

Figure 11 Output ripple filter

Extra care should be taken when long leads or traces are used to provide power to the load. Long lead lengths increase the chance for noise to appear on the lines. Under these conditions C_2 can be added across the load, with a $1\mu F$ ceramic capacitor C_2 in parallel generally as shown in Figure 12.

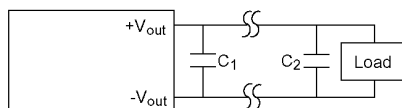

Figure 12 Output ripple filter for a distant load

Decoupling

The converter does not always create noise on the power distribution system. High-speed analog or digital loads with dynamic power demands can cause noise to cross the power inductor back onto the input lines. Noise can be reduced by decoupling the load. In most cases, connecting a $10\mu F$ ceramic capacitor in parallel with a $0.1\mu F$ ceramic capacitor across the load will decouple it. The capacitors should be connected as close to the load as possible.

Ground Loops

Ground loops occur when different circuits are given multiple paths to common or earth ground, as shown in Figure 13. Multiple ground points can slightly different potential and cause current flow through the circuit from one point to another. This can result in additional noise in all the circuits. To eliminate the problem, circuits should be designed with a single ground connection as shown in Figure 14.

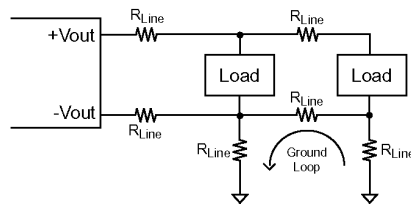

Figure 13 Ground loops

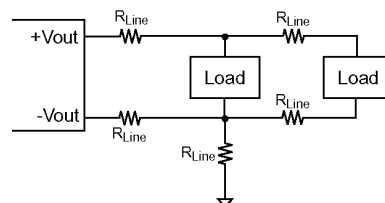

Figure 14 Single point ground

Output Over-Voltage Protection

The output over-voltage protection consists of circuitry that monitors the voltage on the output terminals. If the voltage on the output terminals exceeds the over voltage protection threshold, then the module will work on hiccup mode. When the over-voltage condition is removed, the converter will automatically restart.

The protection mechanism is such that the unit can continue in this condition until the fault is cleared.

Over-Temperature Protection

These modules feature an over-temperature protection circuit to safeguard against thermal damage. The module will work in intermittent mode when the maximum device reference temperature is exceeded. When the over-temperature condition is removed, the converter will automatically restart.

Design Consideration

Typical Application

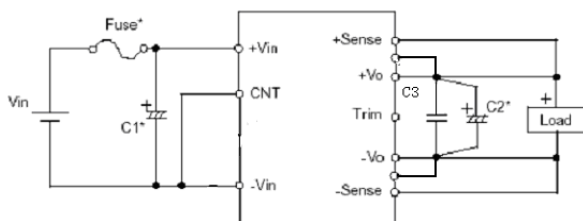

Fig 15 Typical application

F1: Fuse*: Use external fuse (fast blow type) for each unit.

For 1.2V output: 5A (Pout=72W)

C1: Recommended input capacitor C1

$\geq 100\mu\text{F}/100\text{V}$ electrolytic or ceramic type capacitor.

C2: Recommended $-5^\circ\text{C} \sim 100^\circ\text{C}$ uses: $2,200\mu\text{F}/10\text{V}$ (electrolytic capacitor)

$-40^\circ\text{C} \sim -5^\circ\text{C}$: For this temperature range, use $2,200\mu\text{F}/50\text{V}$ electrolytic capacitor and $220\mu\text{F}/10\text{V}$ tantalum capacitor.

C3: Recommended $1\mu\text{F}/10\text{V}$

Fusing

The AVE300-48S1V2 power module has no internal fuse. An external fuse must always be employed! To meet international safety requirements, a 250 Volt rated fuse should be used. If one of the input lines is connected to chassis ground, then the fuse must be placed in the other input line.

Standard safety agency regulations require input fusing. Recommended fuse ratings for the AVE300-48S1V2 are shown as following list.

For 1.2V output :5A (Pout=72W)

Note: the fuse is fast blow type.

Input Reverse Voltage Protection

Under installation and cabling conditions where reverse polarity across the input may occur, reverse polarity protection is recommended. Protection can easily be provided as shown in Figure 16. In both cases the diode used is rated for 15A/100V. Placing the diode across the inputs rather than in-line with the input offers an advantage in that the diode only conducts in a reverse polarity condition, which increases circuit efficiency and thermal performance.

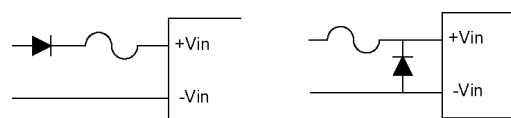

Figure 16 Reverse polarity protection circuit

EMC

For conditions where EMI is a concern, a different input filter can be used. Figure 10 shows a filter designed to reduce EMI effects. AVE300-48S1V2 can meet EN55022 CLASS A with Figure 17.

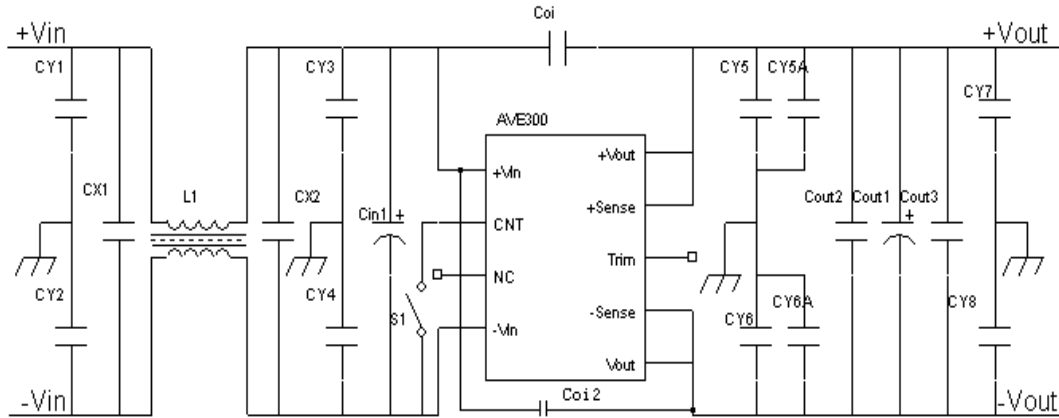

Figure 17 EMI reduction filter

Recommended values:

Component	Value / Rating	Type
Cin1	100uF	Aluminum Electrolytic
CX1	4.7uF	Metal film or ceramic high frequency capacitor
L1	4mH	Mn-Zn Common mode Core 20
CX2	-	-
CY1, CY2	0.22u /275V	Safety Y capacitor
CY3, CY4	-	-
CY5, CY6	0.047uF	Safety Y capacitor
CY5A, CY6A	0.47 uF	Safety Y capacitor
CY7, CY8	33nF	Safety Y capacitor
Cout1	2200uF/16V	Aluminum Electrolytic
Cout2	1uF/63V	Metal film capacitor
Cout3	1uF/50V/SC1206	Chip Capacitor
Coi	0.022uF	Safety Y capacitor
Coi2	0.0022uF	Safety Y capacitor

Safety Consideration

For safety-agency approval of the system in which the power module is used, the power module must be installed in compliance with the spacing and separation requirements of the end-use safety agency standard, i.e., UL60950, CSA C22.2, and EN60950. AVE300-48S1V2 input-to-output isolation is a basic insulation. The DC/DC power module should be installed in end-use equipment, in compliance with the requirements of the ultimate application, and is intended to be supplied by an isolated secondary circuit. When the supply to the DC/DC power module meets all the requirements for SELV (<60Vdc), the output is considered to remain within SELV limits (level 3). If connected to a 60Vdc power system, double or reinforced insulation must be provided in the power supply that isolates the input from any hazardous voltages, including the ac mains. One input pin and one output pin are to be grounded or both the input and output pins are to be kept floating. Single fault testing in the power supply must be performed in combination with the DC/DC power module to demonstrate that the output meets the requirement for SELV. The input pins of the module are not operator accessible.

Note: Do not ground either of the input pins of the module, without grounding one of the output pins. This may allow a non-SELV voltage to appear between the output pin and ground. The circuit cannot withstand transient over-voltage.

Thermal Consideration

Technologies

AVE300-48S1V2 modules have ultra high efficiency at full load. With less heat dissipation and temperature-resistant components such as ceramic capacitors, these modules exhibit good behavior during pro-longed exposure to high temperatures. Maintaining the operating board temperature within the specified range help keep internal component temperatures within their specifications which in turn help keep MTBF from falling below the specified rating. Proper cooling of the power modules is also necessary for reliable and consistent operation.

Basic Thermal Management

Measuring the board temperature of the module is shown in Figure 18 (with baseplate) and Figure 19 (without baseplate) can verify the proper cooling.

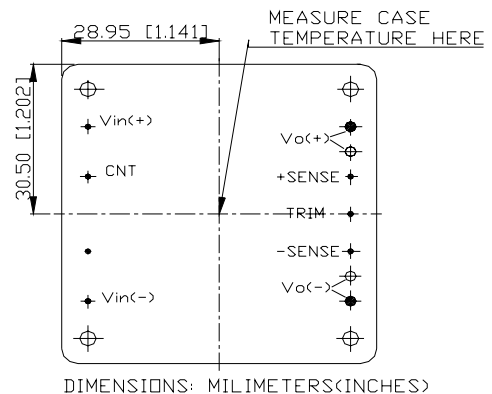

Figure 18 Temperature measurement location (with baseplate)

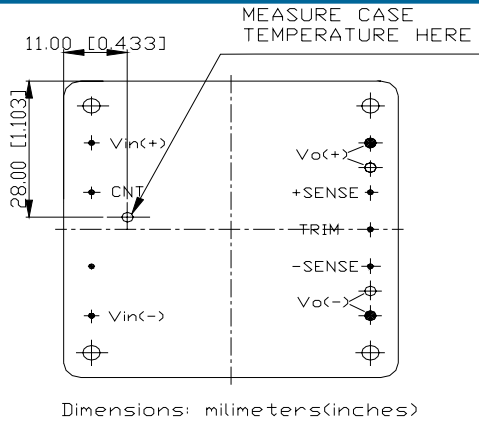

Figure 19 Temperature measurement location (without baseplate)

The module should work under 85°C ambient for the reliability of operation and the board temperature must not exceed 105°C (without baseplate) or 100°C (with baseplate) while operating in the final system configuration. The measurement can be made with a surface probe after the module has reached thermal equilibrium. No heatsink is mounted, make the measurement as close as possible to the indicated position. It makes the assumption that the final system configuration exists and can be used for a test environment. Note that the board temperature of module must always be checked in the final system configuration to verify proper operational due to the variation in test conditions. Thermal management acts to transfer the heat dissipated by the module to the surrounding environment. The amount of power dissipated by the module as heat (PD) is got by the equation below:

$$PD = PI - PO$$

Where PI is input power; PO is output power; PD is dissipated power.

Also, module efficiency (η) is defined as the following equation:

$$\eta = PO / PI$$

If eliminating the input power term, from two above equations can yield the equation below:

$$PD = PO (1 - \eta) /$$

The module power dissipation then can be calculated through the equation.

Because each power module output voltage has a different power dissipation curve, a plot of power dissipation versus output current over three different line voltages is given in the following figures.

Module Derating

Experiment Setup

From the experimental set up shown in Figure 20, the derating curves as Figure 22 can be drawn. Note that the Printed Wiring Board (PWB) and the module must be mounted vertically. The Passage has a rectangular cross-section. The clearance between the facing PWB and the top of the module is kept 13 mm (0.5 in.) constantly.

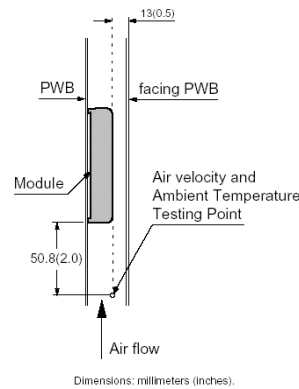

Figure 20 Experiment setup

Convection Without Heatsinks

Increasing the airflow over the module can enhance heat transfer. Figure 21 and figure 22 shows the change of the module output current with the change of ambient temperature. In the test, the airflow was created with externally adjustable fans. The appropriate airflow for a

given operating condition can be determined through this figure.

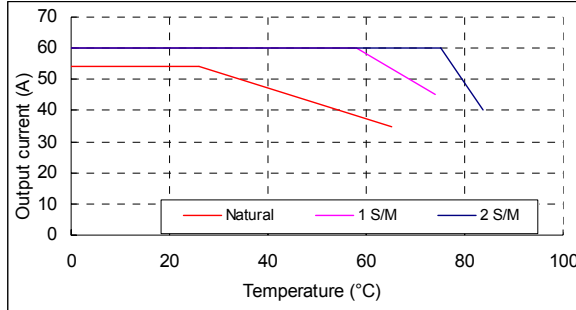

Figure 21 Forced convection power derating without baseplate

Airflow direction from Vin(+) to Vin(-): Vin=48V;

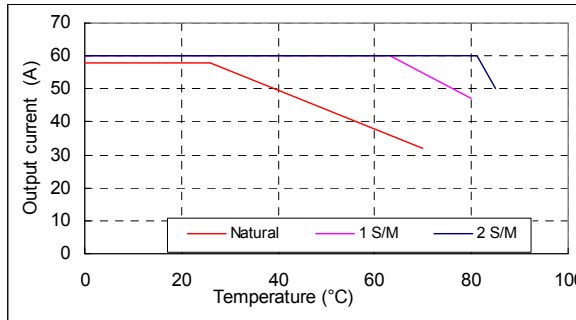

Figure 22 Forced convection power derating with baseplate

Airflow direction from Vin(+) to Vin(-): Vin=48V

Heatsink Configuration

Several standard heatsinks available for the AVE300-48S1V2 are shown in Figure 23 to 25.

The heatsinks mounted to the top surface of the module with screws torqued to 0.56 N-m (5 in.-lb). A thermally conductive dry pad or thermal grease is placed between the case and the heatsink to minimize contact resistance (typically 0.1°C/W to 0.3°C /W) and temperature differential.

Nomenclature for heatsink configurations is as follows:

WDxyyy40

x = fin orientation: longitudinal (L) or transverse (T)

yyy = heatsink height (in 100ths of inch)

For example, WDT5040 is a heatsink that is transverse mounted for a 61mm × 57.9mm (2.4in × 2.28in) module with a heatsink height of 0.5 in.

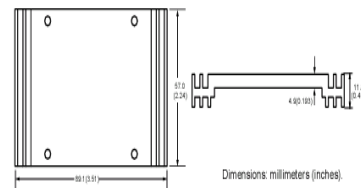

Figure 23 Non-standard heatsink

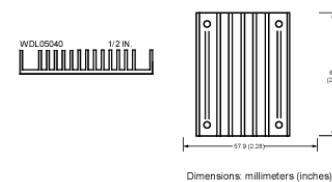

Figure 24 Longitudinal fins heatsink

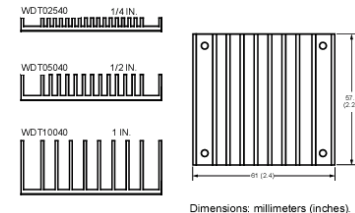

Figure 25 Transverse fins heatsink

Heatsink Mounting

A crucial part of the thermal design strategy is the thermal interface between the baseplate of the module and the heatsink. Inadequate measures taken will quickly negate any other attempts to control the baseplate temperature. For example, using a conventional dry insulator can result in a case-heatsink thermal impedance of >0.5°C/W, while use one of the recommended interface methods (using silicon grease or thermal pads) can result in a case-heatsink thermal impedance around 0.1°C/W.

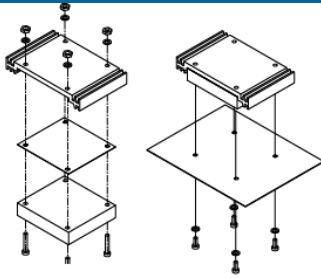

Figure 26 Heatsink mounting

Installation

Although AVE300-48S1V2 converters can be mounted in any orientation, free air-flowing must be taken. Normally power components are always put at the end of the airflow path or have the separate airflow paths. This can keep other system equipment cooler and increase component life spans.

Soldering

AVE300-48S1V2 converter is compatible with standard wave soldering techniques. When wave soldering, the converter pins should be preheated for 20-30 seconds at 110°C, and wave soldered at 260°C for less than 10 seconds.

When hand soldering, the iron temperature should be maintained at 425°C and applied to the converter pins for less than 5 seconds. Longer exposure can cause internal damage to the converter. Cleaning can be performed with cleaning solvent IPA or with water.

Mechanical Chart

With no base plate:

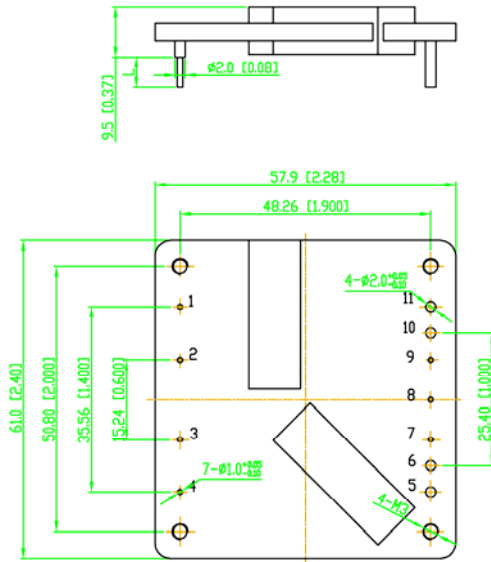

Pin Assignments

1. +Vin
2. CNT
3. NC
4. -Vin
5. -Vout
6. NC
7. -Sense
8. Trim
9. +Sense
10. NC
11. +Vout

Pin Length

4.8mm	-4
3.8mm	-6
2.8mm	-8
5.8mm	None

With base plate:

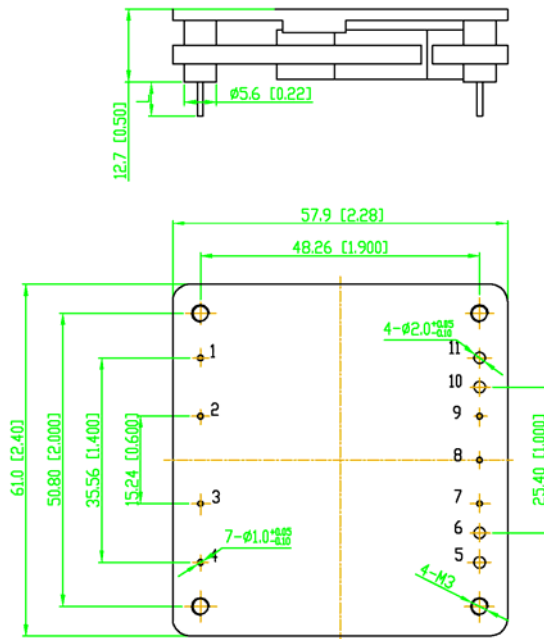

Pin Assignments

1. +Vin
2. CNT
3. NC
4. -Vin
5. -Vout
6. NC
7. -Sense
8. Trim
9. +Sense
10. NC
11. +Vout

Pin Length

4.8mm	-4
3.8mm	-6
2.8mm	-8
5.8mm	None

Ordering Information

Model Number	Input Voltage (V)	Output Voltage (V)	Output Current (A)	Ripple & Noise (mV pp, Max.)	Efficiency (%) Typ.
AVE300-48S1V2-4	36-75	1.2	60	100	86
AVE300-48S1V2B-4	36-75	1.2	60	100	86
AVE300-48S1V2P-4	36-75	1.2	60	100	86
AVE300-48S1V2PB-4	36-75	1.2	60	100	86