

Description

The AGH100-48S3V3B is a single output DC-DC converter with standard half-brick outline and pin configuration. It delivers up to 25A output current with 3.3V output voltage. Above 92% efficiency and excellent thermal performance make it an ideal choice to supply power in telecom and datacom. It can work under -40°C ~ +85°C in 36V ~ 75V wide input range.



Operational Features

- Delivers up to 25A output current
- High efficiency: 92.4% (typ., full load, 48V). 92.6% (typ., half load, 48V).
- Wide input range: 36V ~ 75V
- Excellent thermal performance
- No minimum load requirement
- Start-up and shut-down monotonically into any normal and pre-biased loads, internal pre-bias function circuit prevents back negative current drawn from external load
- RoHS 6 compliant

Control Features

- Remote control function (negative or positive logic optional)
- Remote output sense
- Trim function: 80% ~ 110%

Protection Features

- Input under voltage lockout
- Output over current protection
- Output over voltage protection
- Over temperature protection

Mechanical Features

- Industry standard half-brick pin-out outline
- Open frame structure and with baseplate option
- Pin length option: 3.8mm, 4.8mm, 5.8mm

Safety & EMC

- Meets safety standards UL 60950-1, CSA-C22.2 NO.60950-1, IEC/EN 60950-1 and GB4943
- Approved by UL and TUV
- Meets 2006/95/EEC and 93/68/EEC directives which facilitate CE marking in user's end product
- Meets conducted emission's requirements of FCC Class (and EN55022 Class A with external filter)

Electrical Characteristics

Full operating ambient temperature range is -40°C to +85°C.

Specifications are subject to change without notice.

Parameter		Min.	Typ.	Max.	Unit	Notes & conditions
Absolute max. ratings						
Input voltage	Non-operating			100	V	100ms
	Operating			80	V	Continuous
Operating temperature		-40		85	°C	
Storage temperature		-55		125	°C	
Voltage at remote ON/OFF pin		-0.7		15	V	
Input characteristics						
Operating input voltage range		36	48	75	V	
Input under-voltage lockout	Turn-on voltage threshold	32	34	36	V	
	Turn-off voltage threshold	30	32	34	V	
	Lockout voltage hysteresis	1	2	3	V	
Max. input current				3.5	A	36V _{in} , full load
No-load input current			0.05	0.1	A	
Standby Input current			0.005	0.01	A	Remote OFF
Inrush current transient rating			0.5	1	A ² s	See Figure 16
Input reflected ripple current			25	40	mA	Through 12μH inductor; see Figure 16
Recommended input fuse				15	A	Fast blow external fuse recommended; see Figure 11
Input filter component values (C/L)			4\4.7		μF\μH	Internal values
Recommended external input capacitance			100		μF	Low ESR capacitor recommended; see Figure 11
Output characteristics						
Output voltage set point (standard option)		3.267	3.300	3.333	V	48V _{in} , full load
Output voltage line regulation			0.02	0.2	%	
			0.66	6.6	mV	
Output voltage load regulation			0.02	0.5	%	
			0.66	16.5	mV	

Parameter		Min.	Typ.	Max.	Unit	Notes & conditions
Output voltage temperature regulation			0.005	0.02	%/°C	
Total output voltage range		3.25	3.30	3.35	V	Over sample, line, load, temperature & life
Output voltage ripple and noise			45	120	mVpp	See Figure 2 20MHz bandwidth; see Figure 16
Operating output current range		0		25	A	
Output DC current-limit inception		27.5	32.5	35	A	Hiccup: auto-restart when over-current condition is removed
Vout pre-bias level			90		%V _o	
Output capacitance		470	1000	20000	μF	While pre-bias function is only required in 10000uF condition. High frequency and low ESR is recommended
Dynamic characteristics						
Dynamic response	50% ~ 75% ~ 50% I _{o,max} , 0.1A/μs		80	200	mV	See Figure 4 Test condition: 25°C, nominal input voltage. See Figure 11
	Setting time		80	400	μs	Recovery to within 1% V _{o,nom}
	50% ~ 75% ~ 50% I _{o,max} , 1A/μs				mV	See Figure 5 Test condition: 25°C, nominal input voltage. See Figure 11
Turn-on transient	Rise time		25	50	ms	Full load, see Figure 6
	Turn-on delay time		9	50	ms	
	Output voltage overshoot		0	2	%V _o	
Efficiency						
100% load (48V _{in})			92.4		%	See Figure 1
50% load (48V _{in})			92.6		%	See Figure 1
20% load (48V _{in})			88		%	See Figure 1

Electrical Characteristics (Continued)

Parameter	Min.	Typ.	Max.	Unit	Notes & conditions	
Isolation characteristics						
Isolation voltage (conditions: 1mA for 60s, slew rate of 1500V/10s)	2000			V	Basic insulation, pollution degree 2, input to output	
	2000			V	Basic insulation, pollution degree 2, input to metal part	
	2000			V	Basic insulation, pollution degree 2, output to baseplate (if available)	
Feature characteristics						
Switching frequency	270		275	kHz		
Remote ON/OFF control (positive logic)	Off-state voltage	-0.7		1.2	V	See Figure 11
	On-state voltage	3.5		15	V	
Remote ON/OFF control (negative logic)	Off-state voltage	3.5		15	V	
	On-state voltage	-0.7		1.2	V	
Output voltage trim range	2.64		3.63	V	See <i>Trim Characteristics of Application Note</i>	
Output voltage remote sense range			10	%		
Output over-voltage protection	3.8	4.0	4.3	V	Hiccup: auto-restart when over-voltage condition is removed	
Over-temperature shutdown (Baseplate: centre of it)		113		°C	Auto recovery; over-temperature protect (OTP) test point; see Figure 10 Tested under thermal balance condition.	
Over-temperature shutdown (RT)	114	119				
Over-temperature hysteresis (RT)		13		°C		
Reliability characteristics						
Calculated MTBF (telcordia)		2		10 ⁶ h	Telcordia SR-332-2006 Method 1 Case3, normal Input/ 80% load, 300LFM, 25°C T _a	

Electromagnetic Compatibility Requirements

Test item	Regulations	Criteria	Notes & conditions
Conducted emission	EN 55022 DC input port, Class A Limits	/	See <i>EMC Test Conditions</i>
Immunity to electrostatic discharge	IEC/EN61000-4-2 Enclosure port, Level 3	B	
Immunity to electrical fast transient	IEC/EN61000-4-4 DC input port, Level 3	B	
Immunity to surges	IEC/EN61000-4-5 DC input port Line to Ground (earth): 600V Line to Line: 600V	B	
Immunity to continuous conducted interference	IEC/EN61000-4-6 DC input port, Level 2	A	
Immunity to voltage dips and short interruptions and voltage variations	EN 61000-4-29 DC input port	B	

Criterion A: Normal performance during and after test.

Criterion B: For EFT and surges, low-voltage protection or reset is not allowed. Temporary output voltage fluctuation ceases after disturbances ceases, and from which the EUT recovers its normal performance automatically.

For Dips and ESD, output voltage fluctuation or reset is allowed during the test, but recovers to its normal performance automatically after the disturbance ceases.

Criterion C: Temporary loss of output, the correction of which requires operator intervention.

Criterion D: Loss of output which is not recoverable, owing to damage to hardware.

Qualification Testing

Parameter	Unit (pcs)	Test condition
Halt test	4 ~ 5	$T_{a,min} - 10^{\circ}\text{C}$ to $T_{a,max} + 10^{\circ}\text{C}$, 5°C step, V_{in} = min to max, 0 ~ 105% load
Vibration	3	Frequency range: 5Hz ~ 20Hz, 20Hz ~ 200Hz, A.S.D: $1.0\text{m}^2/\text{s}^3$, -3db/oct, axes of vibration: X/Y/Z Time: 30min/axis
Mechanical shock	3	30g, 6ms, 3axes, 6directions, 3time/direction
Thermal shock	3	-40°C to 100°C , unit temperature 20cycles
Thermal cycling	3	-40°C to 55°C , temperature change rate: $1^{\circ}\text{C}/\text{min}$, cycles: 2cycles
Humidity	3	40°C , 95%RH, 48h
Solder ability	15	IPC J-STD-002C-2007

Characteristic Curves

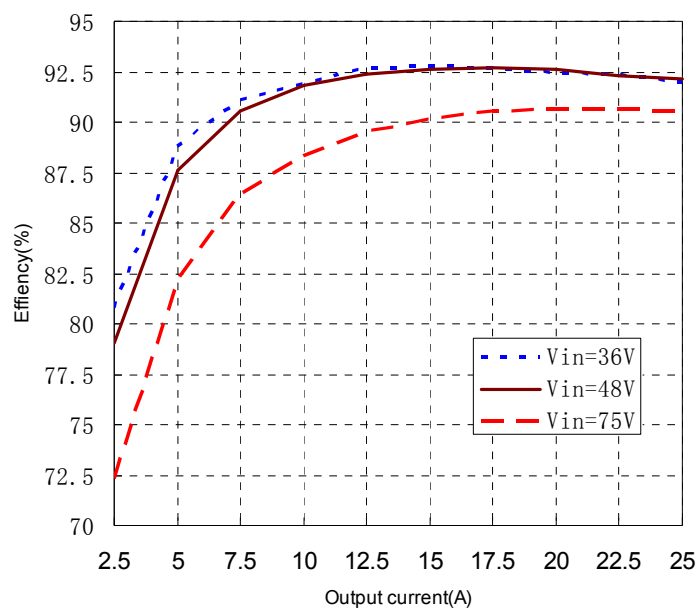

Figure 1 Efficiency vs. output current, $T_a = 25^{\circ}\text{C}$, $V_o = 3.3\text{V}$

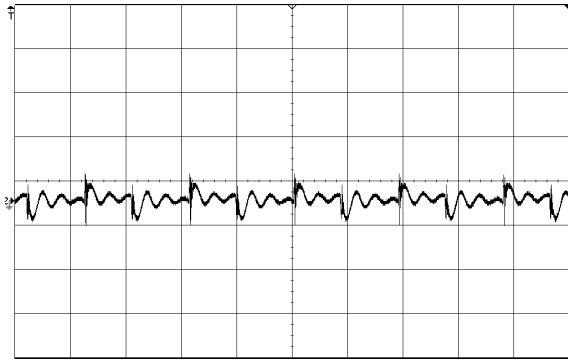

Figure 2 Output ripple & noise (2 μ s/div, 50mV/div), see Figure 16 for test configuration

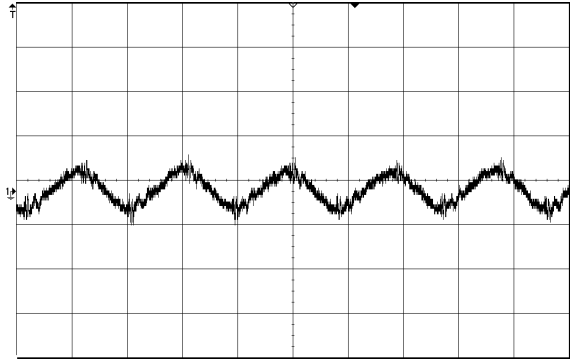

Figure 3 Input reflected ripple current (2 μ s/div, 5mA/div), see Figure 16 for test configuration

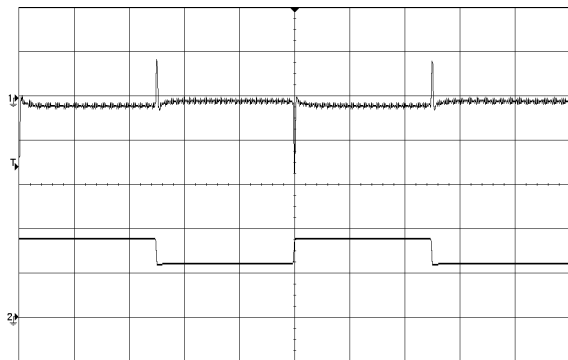

Figure 4 Dynamic response for 25% load step (50% ~ 75% ~ 50%) and 0.1A/ μ s slew rate, (2ms/div), see Figure 11 for test configuration; CH1-output voltage (50mV/div); CH2-output current (2A/div)

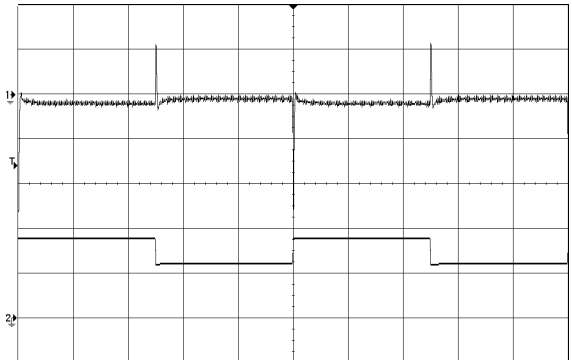

Figure 5 Dynamic response for 25% load step (50% ~ 75% ~ 50%) and 1A/ μ s slew rate, (2ms/div), see Figure 11 for test configuration; CH1-output voltage (50mV/div); CH2-output current (2A/div)

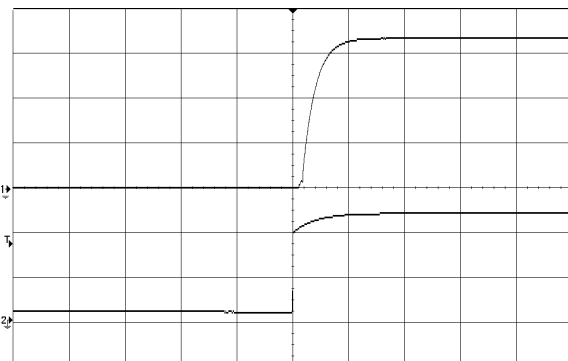

Figure 6 Output voltage startup by power on, (50ms/div), see Figure 11 for test configuration; CH1-output voltage (1V/div); CH2-input voltage (20V/div)

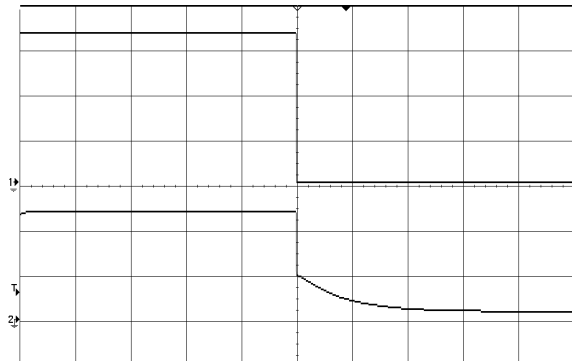

Figure 7 Output voltage shut down by power off, (200ms/div), see Figure 11 for test configuration; CH1-output voltage (1V/div); CH2-input voltage (20V/div)

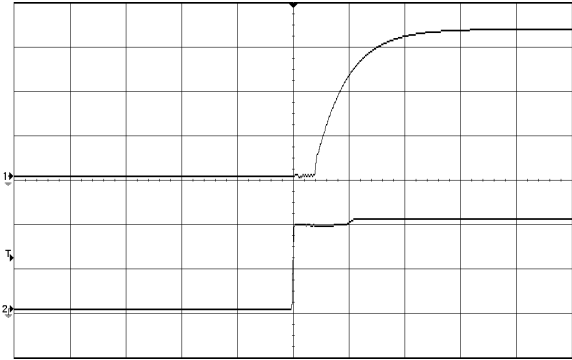

Figure 8 Output voltage startup by remote ON, (20ms/div), see Figure 11 for test configuration; CH1-output voltage (1V/div); CH2-remote ON voltage (5V/div)

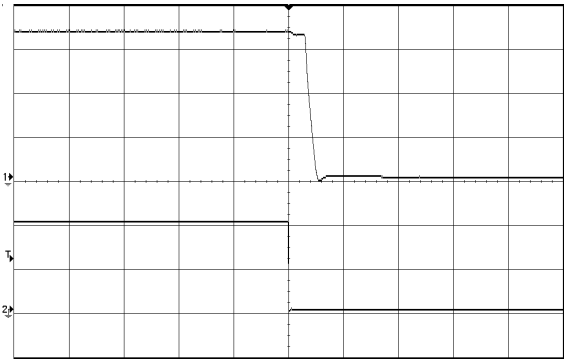

Figure 9 Output voltage shutdown by remote OFF, (500µs/div), see Figure 11 for test configuration; CH1-output voltage (1V/div); CH2-remote OFF voltage (5V/div)

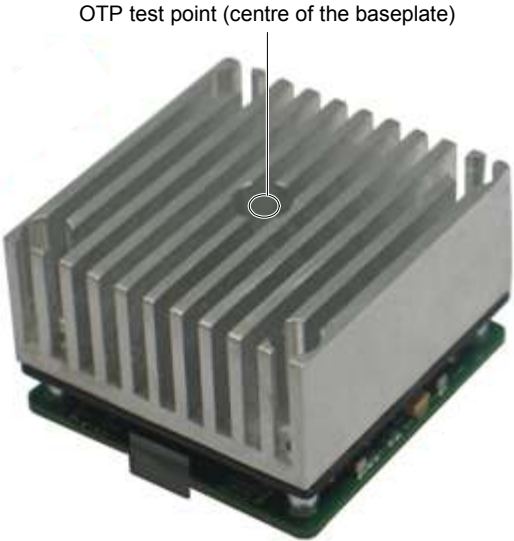

Figure 10 OTP test point (centre of the baseplate)

Application Note

Typical Application

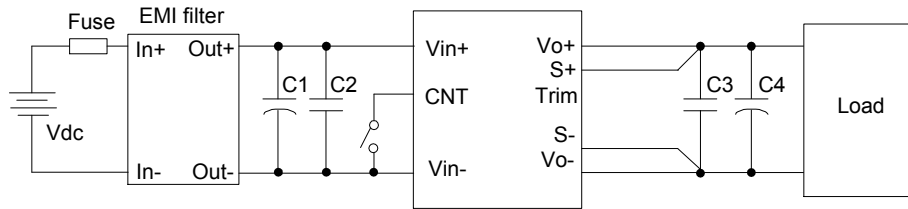

Figure 11 Typical application

C1: 100µF/100V electrolytic capacitor, P/N: UPW2A101MHD (Nichicon) or equivalent caps
 C2: 1µF/100V X7R ceramic capacitor, P/N: C3225X7R2A105KT0L0U (TDK) or equivalent caps
 C3: 1µF/25V X7R ceramic capacitor, P/N: C3225X7R1E105KT000N (TDK) or equivalent caps
 C4: 470µF electrolytic capacitor, P/N: UUD1H471MNL1GS (Nichicon) or equivalent caps
 Fuse: Fast blow external fuse with a rating of 15A. The recommended fuse model is 314015P from LITTLEFUSE.

Remote ON/OFF

Either positive or negative remote ON/OFF logic is available in AGH100-48S3V3-4L. The logic is CMOS and TTL compatible.

Figure 12 is the detailed internal circuit and reference in AGH100-48S3V3-4L.

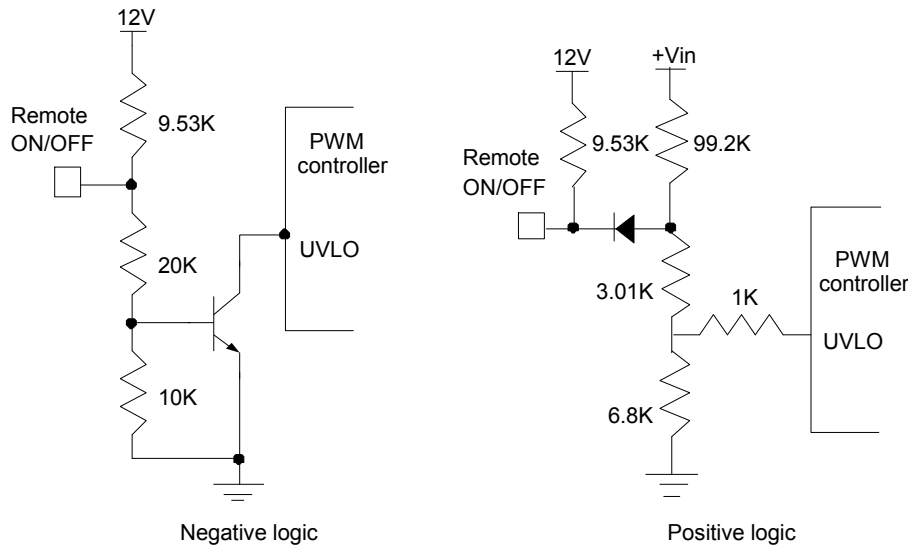

Figure 12 Remote ON/OFF internal diagram

The voltage between pin Remote ON/OFF and pin Vin- must not exceed the range listed in table “Feature characteristics” to ensure proper operation. The external Remote ON/OFF circuit is highly recommended as shown in Figure 13.

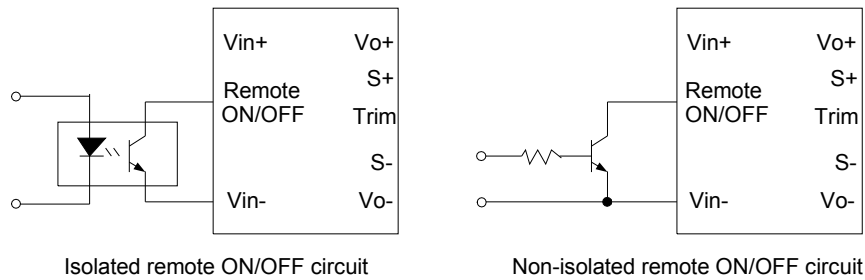

Figure 13 External Remote ON/OFF circuit

Trim Characteristics

Connecting an external resistor between Trim pin and Vo- pin will decrease the output voltage, while connecting it between Trim and Vo+ will increase the output voltage. The following equations determine the external resistance to obtain the trimmed output voltage.

$$R_{adj-down} = \frac{510}{\Delta} - 10.2(K\Omega)$$

$$R_{adj-up} = \frac{5.1 \times V_{norm} \times (100 + \Delta)}{1.225 \times \Delta} - \frac{510}{\Delta} - 10.2(K\Omega)$$

$$\Delta = \frac{|V_{norm} - V_{desired}|}{V_{norm}} \times 100$$

V_{norm} : Nominal output voltage.

For example, to get 3.63V output, the trimming resistor is

$$R_{adj-up} = \frac{5.1 \times 3.3 \times (100 + 10)}{1.225 \times 10} - \frac{510}{10} - 10.2(K\Omega) = 89.9(K\Omega)$$

The output voltage can also be trimmed by potential applied at the Trim pin.

$$V_o = (V_{trim} + 1.225) \times 2.69$$

In the above equation V_{trim} is the potential applied at the Trim pin, and V_o is the desired output voltage.

When trimming up, the output current should be decreased accordingly so as not to exceed the maximum output power and the minimum input voltage should be increased as shown in below figures.

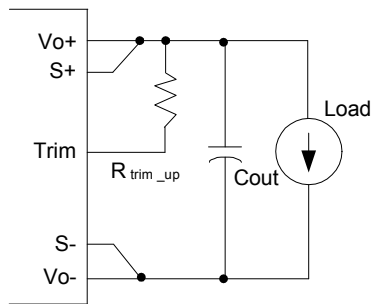

Figure 14 Trim up

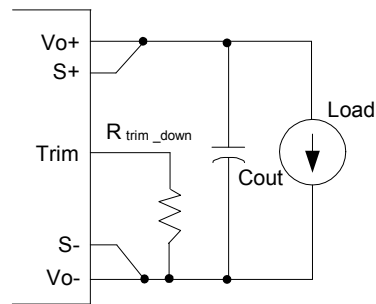

Figure 15 Trim down

Sense Characteristics

If the load is far from the unit, connect S+ and S- to the terminal of the load respectively to compensate the voltage drop on the transmission line. See Figure 11. If the sense compensate function is not necessary, connect S+ to Vo+ and S- to Vo- directly.

Input Ripple & Inrush Current And Output Ripple & Noise Test Configuration

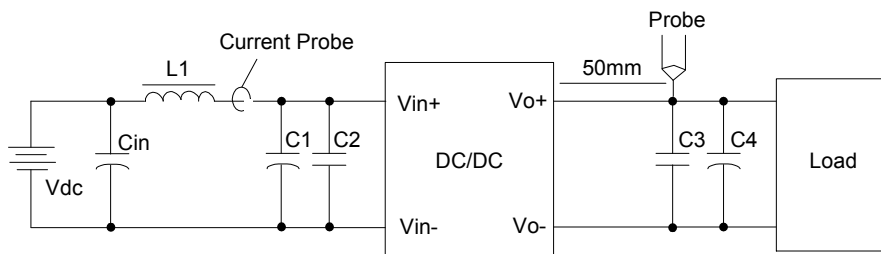

Figure 16 Input ripple & inrush current, ripple & noise test configuration

Vdc: DC power supply

L1: 12μH

Cin: 220μF/100V typical

C1 ~ C4: See Figure 11

Note: Using a coaxial cable with series 50Ω resistor and 0.68μF ceramic capacitor or a ground ring of probe to test output ripple & noise is recommended.

EMC Test Conditions

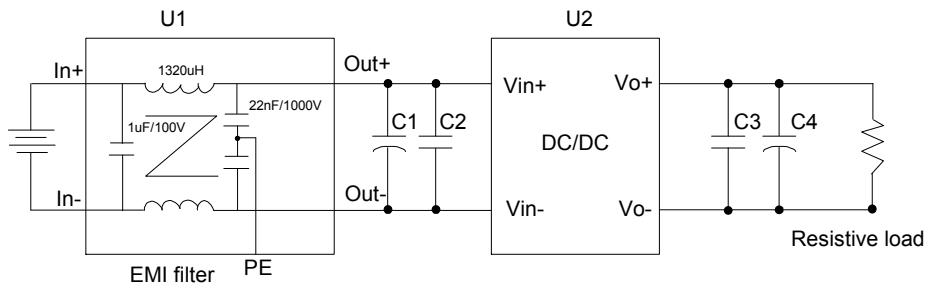

Figure 17 EMC test configuration

- U1: 5A input EMC filter module
- U2: Module to test, AGH100-48S3V3B
- C1 ~ C4: See Figure 11

Thermal Considerations

The converter is designed to operate in different thermal environments and sufficient cooling must be provided. Proper cooling can be verified by measuring the temperature at the temp test points. The temperatures at these points should not exceed the max. values in Table 1. For the typical application, Figure 20 shows the derating of output current vs. ambient air temperature at different air velocity.

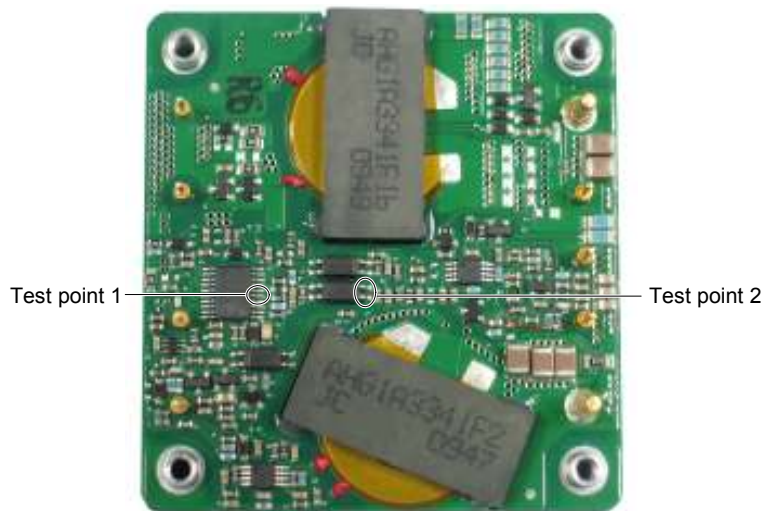

Figure 18 Temperature test points

Table 1 Temperature limit of test points

Test point	Temperature limit
Test point 1	118°C
Test point 2	112°C

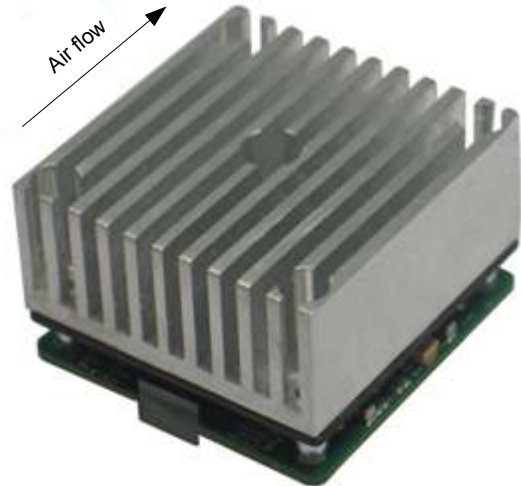

Figure 19 Typical test condition, forced airflow direction is from V_{in-} to V_{in+}

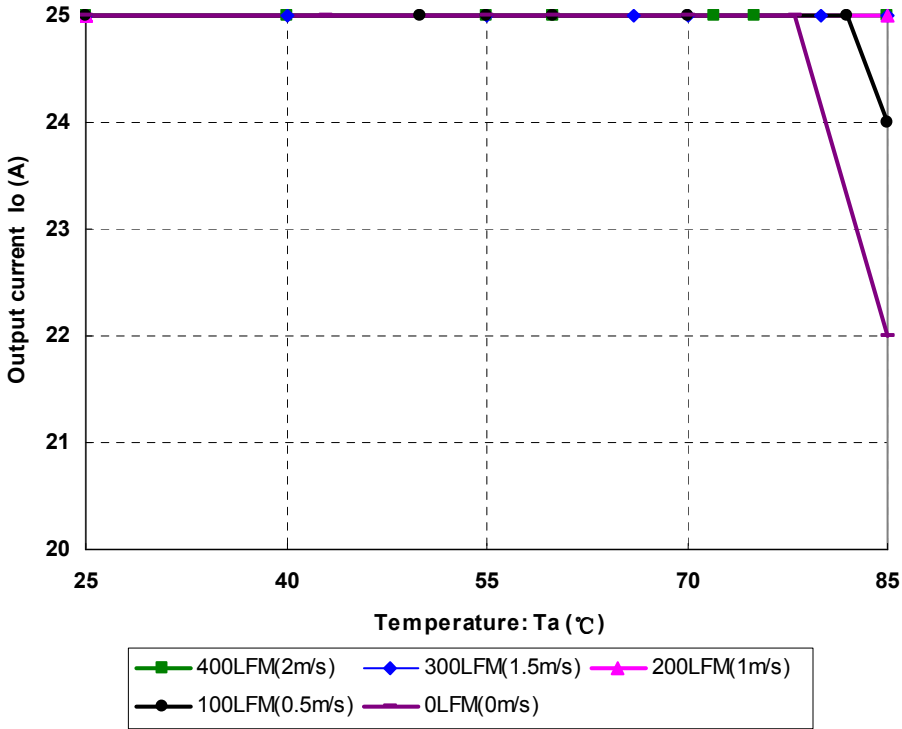
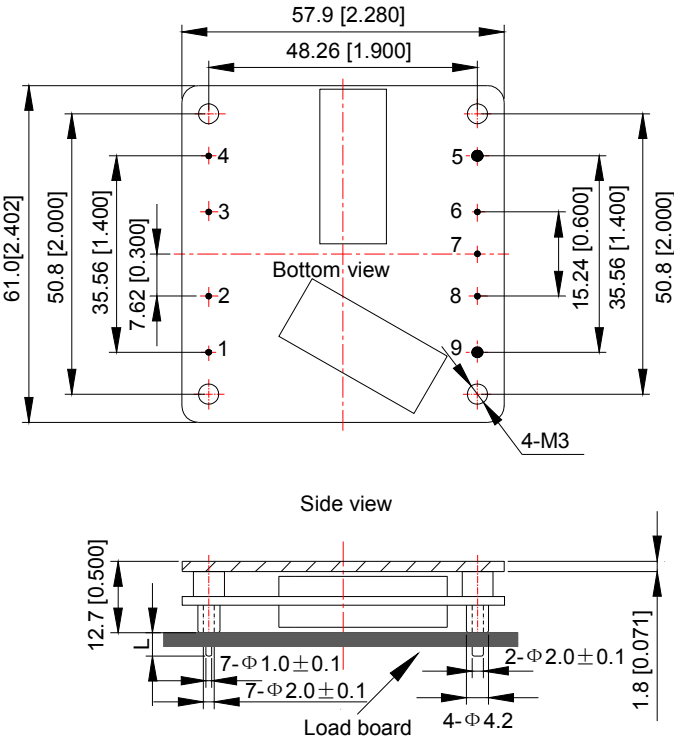

Figure 20 Output power derating, 48V_{in} with air flowing across the converter from V_{in-} to V_{in+}

Mechanical Diagram



Unit: mm[inch] Bottom view: pin on upside
 Tolerance: X.Xmm ± 0.5mm[X.X in. ± 0.02in.]
 X.XXmm ± 0.25mm[X.XX in. ± 0.01in.]

Figure 21 Mechanical diagram

Pin length option

Device code suffix	L
-4	4.8mm ± 0.5mm
-6	3.8mm ± 0.5mm
-8	2.8mm ± 0.5mm
None	5.8mm ± 0.5mm

Pin Designations

Pin No.	Name	Function
1	V _{in+}	Positive input voltage
2	Remote ON/OFF	Remote control
3	Case	
4	V _{in-}	Negative input voltage
5	V _{o-}	Negative output voltage
6	S-	Negative remote sense
7	Trim	Output voltage trim
8	S+	Positive remote sense
9	V _{o+}	Positive output voltage

Soldering

The product is intended for standard manual or wave soldering.

When wave soldering is used, the temperature on pins is specified to maximum 260°C for maximum 7s.

When soldering by hand, the iron temperature should be maintained at 300°C ~ 380°C and applied to the converter pins for less than 10s. Longer exposure can cause internal damage to the converter.

Cleaning of solder joint can be performed with cleaning solvent IPA or simulative.

Ordering Information

AGH100	-	48	S	3V3	P	-	4	L
①		②	③	④	⑤		⑥	⑦

①	Model series	AGH: high efficiency quarter brick series, 100: output power 82.5W
②	Input voltage	48: 36V ~ 75V input range, rated input voltage 48V
③	Output number	S: single output
④	Rated output voltage	3V3: 3V3 output
⑤	Remote ON/OFF logic	Default: negative; P: positive logic
⑥	Pin length	-4: 4.8mm
⑦	RoHS status	L: RoHS, R6; Y: RoHS, R5

Model number	Description
AGH100-48S3V3-4L	4.8mm pin length; negative on/off logic; R6 compliant
AGH100-48S3V3P-4L	4.8mm pin length; positive on/off logic; R6 compliant
AGH100-48S3V3B-4L	4.8mm pin length; negative on/off logic; baseplate; R6
AGH100-48S3V3PB-4L	4.8mm pin length; positive on/off logic; baseplate; R6

Hazardous Substances Announcement (RoHS Of China)

Parts	Hazardous substances					
	Pb	Hg	Cd	Cr ⁶⁺	PBB	PBDE
AGH100-48S3V3	x	x	x	x	x	x
<p>x: Means the content of the hazardous substances in all the average quality materials of the part is within the limits specified in SJ/T-11363-2006</p> <p>√: Means the content of the hazardous substances in at least one of the average quality materials of the part is outside the limits specified in SJ/T11363-2006</p> <p>Emerson Network Power Co., Ltd. has been committed to the design and manufacturing of environment-friendly products. It will reduce and eventually eliminate the hazardous substances in the products through unremitting efforts in research. However, limited by the current technical level, the following parts still contain hazardous substances due to the lack of reliable substitute or mature solution:</p> <ol style="list-style-type: none"> 1. Solders (including high-temperature solder in parts) contain plumbum. 2. Glass of electric parts contains plumbum. 3. Copper alloy of pins contains plumbum 						