

## Description

The AVO100-48S05 is a single output DC-DC converter with standard eighth-brick outline and pin configuration. It delivers up to 20A output current with 5V output voltage. It provides CNT, remote control, trim and sense functions, with OVP, OCP, OTP full protection method. Pre-bias start-up capability is realized. Efficiency above 92.8% and excellent thermal performance make it an ideal choice for telecom and datacom application. It can work under -40°C ~ +85°C.

## Operational Features

- Up to 20A output current
- Ultra-high efficiency 92.8% typ. at full load
- Wide input range: 36V ~ 75V
- Pre-bias function
- Excellent thermal performance
- No minimum load requirement
- Fixed frequency operation
- Intended for reflow or wave soldering
- RoHS 6 compliant

## Control Features

- Remote control function
- Remote output sense
- Trim function: -20% ~ +10%

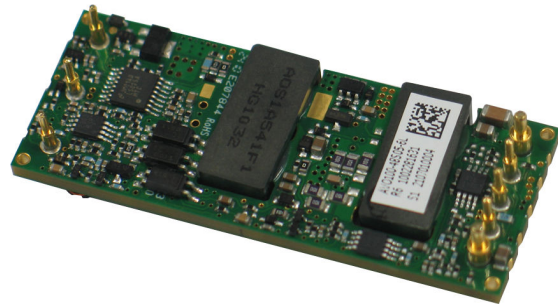

## Protection Features

- Input under-voltage lockout
- Output over-current protection
- Output over-voltage protection
- Over-temperature protection

## Mechanical Features

- Industry standard eighth-brick pin-out outline
- Open frame
- Pin length: 3.8mm

## Safety & EMC

- Meets safety standards UL 60950-1, IEC/EN 60950-1 and GB4943
- Approved by UL and TUV
- Meets 2006/95/EEC and 93/68/EEC directives which facilitates CE marking in user's end product
- Meets conducted emission's requirements of FCC Class A and EN55022 Class A with external filter

## Electrical Characteristics

Full operating ambient temperature range is -40°C to +85°C.

Specifications are subject to change without notice.

\*Test condition: Ta: 25°C. Air velocity: 300LFM.

Parameter		Min.	Typ.	Max.	Unit	Notes & conditions
<b>Absolute max. ratings</b>						
Input voltage	Non-operating			100	V	100ms
	Operating			80	V	Continuous
Operating temperature		-40		+85	°C	
Storage temperature		-55		+125	°C	
Voltage at remote ON/OFF pin		-0.7		12	V	
<b>Input characteristics</b>						
Operating input voltage range		36	48	75	V	
Input under-voltage lockout	Turn-on voltage threshold	31	34	36	V	
	Turn-off voltage threshold	30	32	35	V	
	Lockout voltage hysteresis	1	2	3	V	
Max. input current				3.5	A	36V <sub>in</sub> , Full load
No-load input current			0.05	0.1	A	
Standby input current			0.01	0.03	A	Remote OFF
Inrush current transient rating			0.5	1	A2s	Figure 15
Input reflected ripple current			15		mA	Through 12μH inductor; Figure 15
Recommended input fuse				10	A	External fast blow fuse is recommended; Figure 11
Input filter component values (C/L)			4.4\3.0		μF\μH	Internal values
Recommended external input capacitance			100		μF	Low ESR capacitor is recommended; Figure 11
<b>Output characteristics</b>						
Output voltage set point (standard option)		4.93	5	5.07	V	48V <sub>in</sub> , full load
Output voltage line regulation			0.1	0.2	%	
			5	10	mV	

Parameter		Min.	Typ.	Max.	Unit	Notes & conditions
Output voltage load regulation			0.2	0.5	%	
			10	25	mV	
Output voltage temperature regulation				0.02	%/°C	
Total output voltage range		4.85	5	5.15	V	Over sample, line, load, temperature & life
Output voltage ripple and noise			40	90	mVpp	Figure 2 20MHz bandwidth; Figure 15
Operating output current range		0		20	A	
Output DC current-limit inception		22		32	A	Hiccup: auto-restart when over-current condition is removed
Output capacitance		220	1000	10000	μF	
<b>Dynamic characteristics</b>						
Dynamic response (output capacitance 220μ)	50% ~ 75% ~ 50% $I_{o,max}$ , 0.1A/μs		80		mV	Figure 4 Test condition: 25°C, nominal input voltage, Figure 11
	50% ~ 75% ~ 50% $I_{o,max}$ , 1A/μs		230		mV	Figure 5 Test condition: 25°C, nominal input voltage, Figure 11
	Settling time		100		μs	Recovery to within 1% $V_{o,nom}$
Turn-on transient	Rise time		5	30	ms	Full load, Figure 6
	Turn-on delay time		3	30	ms	
	Output voltage overshoot		0		% $V_o$	
<b>Efficiency</b>						
100% load			92.8		%	Figure 1
60% load			92.4		%	Figure 1

## Electrical Characteristics (Continued)

Parameter		Min.	Typ.	Max.	Unit	Notes & conditions
<b>Isolation characteristics</b>						
Isolation voltage (conditions: 1mA for 60s, slew rate of 2000V/10s)		2250			V	Basic insulation, pollution degree 2, input to output
<b>Feature characteristics</b>						
Switching frequency		280	310	360	kHz	
Remote ON/OFF control (negative logic)	Off-state voltage	3.5		12	V	Figure 12
	On-state voltage	-0.7		1.2	V	
Output voltage trim range		4		5.5	V	See <i>Trim Characteristics of Application Note</i>
Output voltage remote sense range				0.5	V	
Output over-voltage protection (static)		115		140	%V <sub>o,nom</sub>	Hiccup: auto-restart when over-voltage condition is removed
Over-temperature shutdown			130		°C	Auto recovery; OTP test point: Figure 10
Over-temperature hysteresis		5			°C	
<b>Reliability characteristics</b>						
Calculated MTBF (telcordia)			1.5		10 <sup>6</sup> h	300LFM, 40C Ta. Normal input/rated output@80%load

## Electromagnetic Compatibility Characteristics

Test item	Regulations	Criteria	Notes & conditions
Conducted emission	EN 55022 DC input port, class A limits	/	See EMC test conditions
Immunity to electrostatic discharge	IEC/EN61000-4-2 Enclosure port, level 3	B	
Immunity to electrical fast transient	IEC/EN61000-4-4 DC input port, level 3	B	
Immunity to surges	IEC/EN61000-4-5 DC input port Line to ground (earth): 600V Line to line: 600V	B	
Immunity to continuous conducted interference	IEC/EN61000-4-6 DC input port, level 2	A	
Immunity to voltage dips and short interruptions and voltage variations	EN 61000-4-29 DC input port	B	

Criterion A: Normal performance during and after test.

Criterion B: For EFT and surges, low-voltage protection or reset is not allowed. Temporary output voltage fluctuation ceases after disturbances ceases, and from which the EUT recovers its normal performance automatically. For dips and ESD, output voltage fluctuation or reset is allowed during the test, but recovers to its normal performance automatically after the disturbance ceases.

## Qualification Testing

Parameter	Unit	Test condition
Halt test	4 ~ 5 pcs	Ta, min-10°C to Ta, max+10°C, 5°C step, V <sub>in</sub> = min. to max., 0 ~ 105% load
Vibration	3 pcs	Frequency range: 5Hz ~ 20Hz, 20Hz ~ 200Hz, A.S.D: 1.0m <sup>2</sup> /s <sup>3</sup> , -3db/oct, axes of vibration: X/Y/Z Time: 30 min/axis
Mechanical shock	3 pcs	30g, 6ms, 3 axes, 6 directions, 3 time/direction
Thermal shock	3 pcs	-40°C to +100°C, unit temperature 20 cycles
Thermal cycling	3 pcs	-40°C to +55°C, temperature change rate: 1°C/min, cycles: 2 cycles
Humidity	3 pcs	40°C, 95%RH, 48h
Solder ability	15 pcs	IPC J-STD-002C-2007

# Characteristic Curves

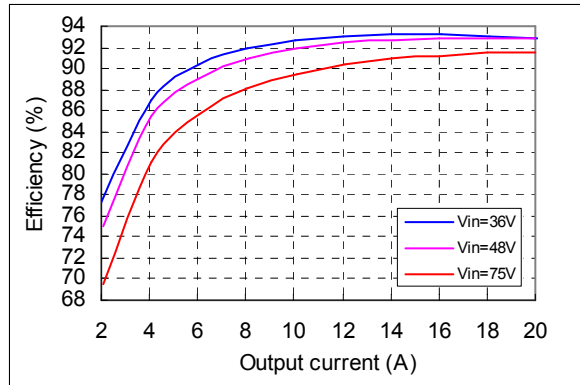

Figure 1 Efficiency vs. output current,  $T_a = 25^\circ\text{C}$ ,  $V_o = 5\text{V}$ , air velocity = 300LFM

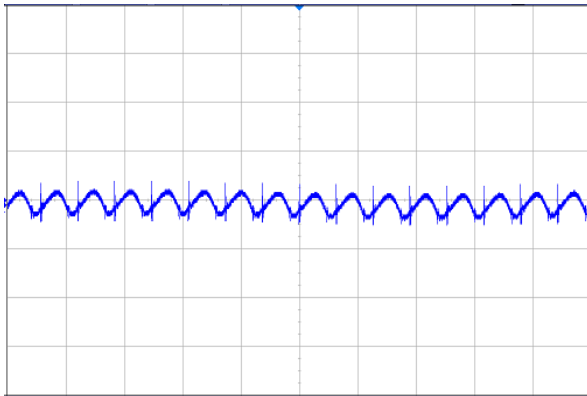

Figure 2 Output ripple & noise (5 $\mu\text{s}/\text{div}$ , 50mV/div), see Figure 15

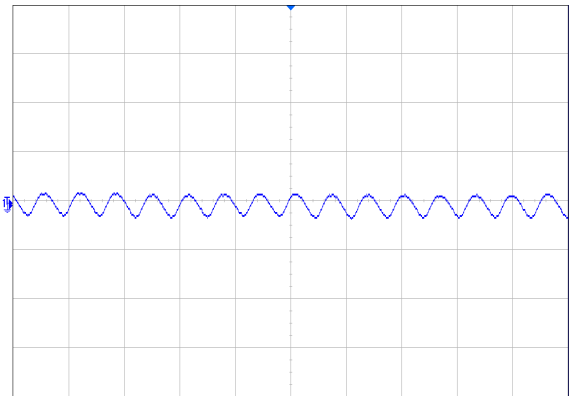

Figure 3 Input reflected ripple current (5 $\mu\text{s}/\text{div}$ , 10mA/div), see Figure 15

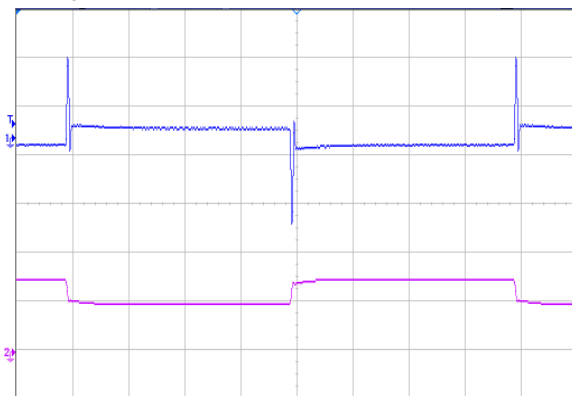

Figure 4 Dynamic response for 25% load step (50% ~ 75% ~ 50%) and 0.1A/ $\mu\text{s}$  slew rate, (1ms/div), see Figure 11; CH1-output voltage (50mV/div) CH2-output current (10A/div)

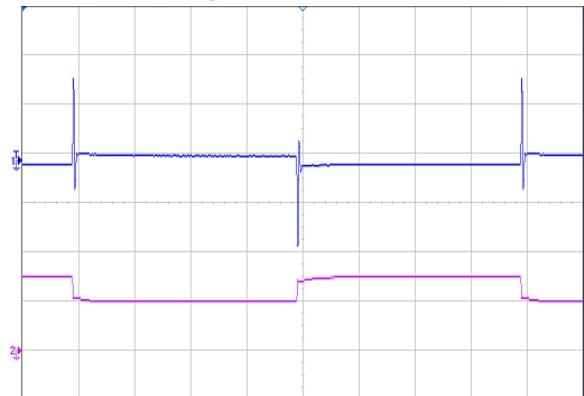

Figure 5 Dynamic response for 25% load step (50% ~ 75% ~ 50%) and 1A/ $\mu\text{s}$  slew rate, (1ms/div), see Figure 11; CH1-output voltage (100mV/div) CH2-output current (10A/div)

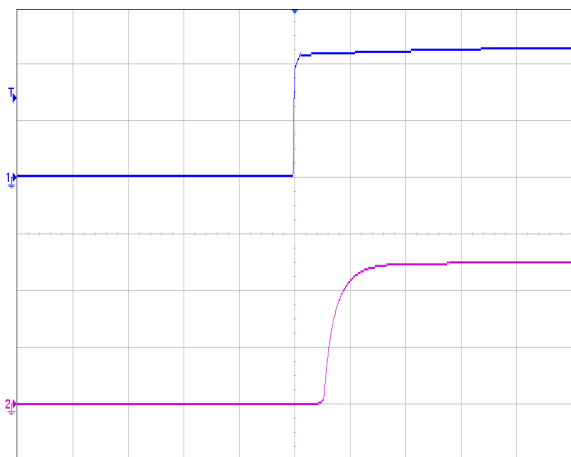

Figure 6 Output voltage startup by power on, (5ms/div), see Figure 11; CH1-input voltage (20V/div) CH2-output voltage (2V/div);

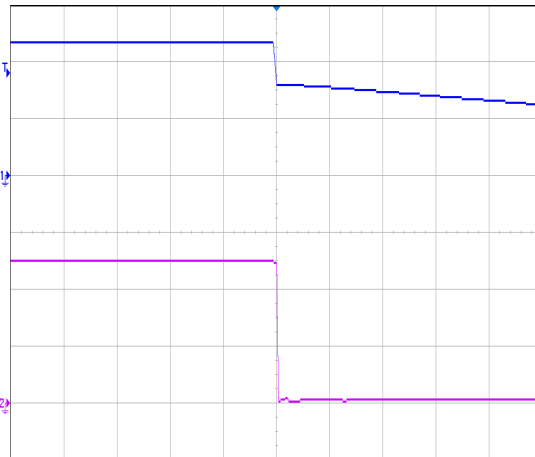

Figure 7 Output voltage shutdown by power off, (10ms/div), see Figure 11; CH1-input voltage (20V/div) CH2-output voltage (2V/div)

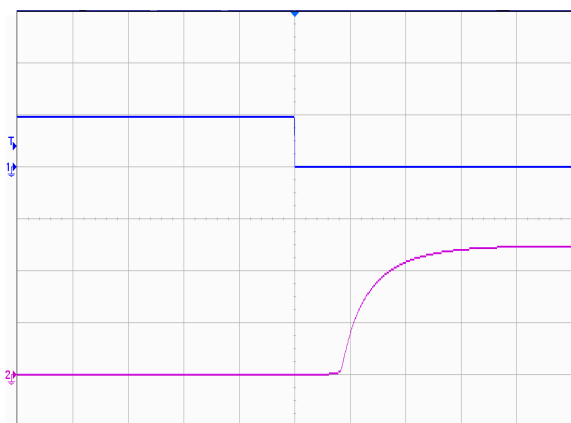

Figure 8 Output voltage startup by remote ON, (2ms/div); see Figure 12; CH1-remote ON voltage (5V/div); CH2-output voltage (2V/div);

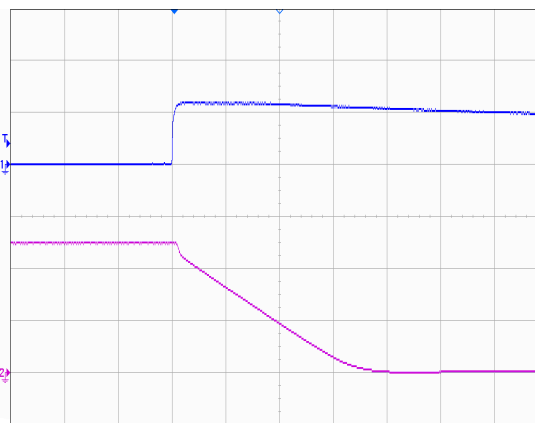

Figure 9 Output voltage shutdown by remote OFF, (100μs/div), see Figure 12; CH1-remote OFF voltage (5V/div); CH2-output voltage (2V/div)

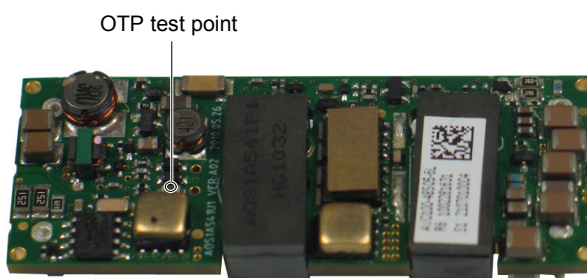

Figure 10 OTP test point

# Application Note

## Typical Application

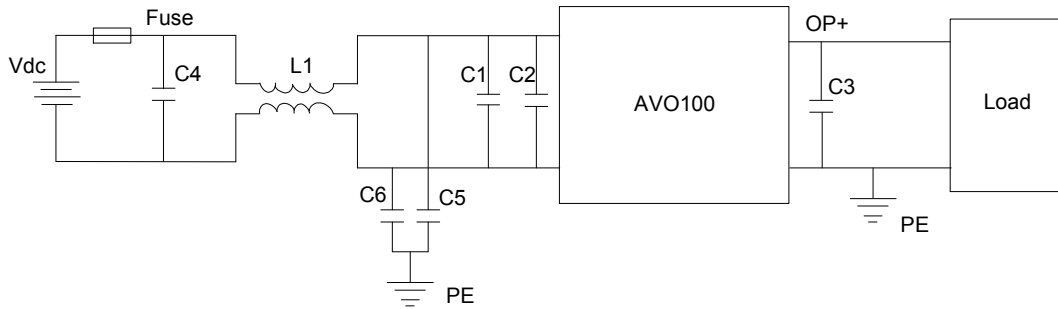

Figure 11 Typical application

Recommended input fuse: LITTLEFUSE 216010.P 10A

C1: SMD ceramic-100V-100nF-±10%-X7R-1206

C2: 100µF/100V electrolytic capacitor, high frequency and low ESR

C3: 1000µF/10V electrolytic capacitor, high frequency and low ESR

C4: SMD ceramic-100V-1000nF-X7R-1210

C5, C6: SMD ceramic-22nF/1000V/X7R-1210

L1: 1320uH-±25%-4A-R5K-21×21×12.5mm

## Remote ON/OFF

Negative remote ON/OFF logic is available in AVO100-48S05. Below is the detailed external circuit in AVO100-48S05.

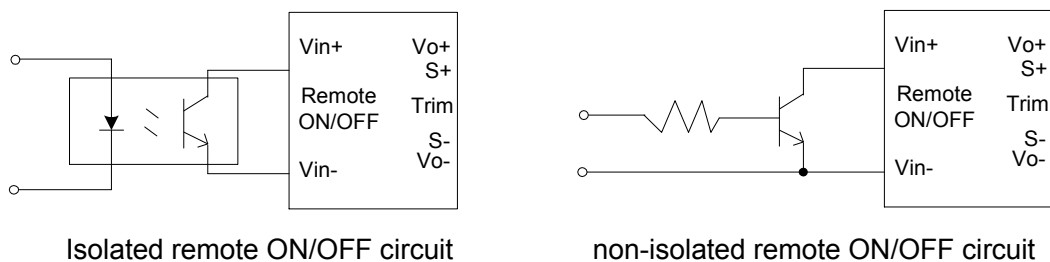

Figure 12 External remote ON/OFF circuit



### Trim Characteristics

Connecting an external resistor between Trim pin and V<sub>o-</sub> pin will decrease the output voltage, while connecting it between Trim and V<sub>o+</sub> will increase the output voltage. The following equations determine the external resistance to obtain the trimmed output voltage.

$$R_{adj-down} = \frac{511}{\Delta} - 10.2(k\Omega)$$

Where  $\Delta = (V_{nom} - V_o) \times 100 / V_{nom}$

$$R_{trim-up} = \frac{5.11 \times V_{nom} \times (100 + \Delta)}{1.225 \times \Delta} - \frac{511}{\Delta} - 10.2(k\Omega)$$

Where  $\Delta = (V_o - V_{nom}) \times 100 / V_{nom}$

$V_{nom}$  : Nominal output voltage.

For example, to get 5.5V output, the trimming resistor is

$$R_{trim-up} = \frac{5.11 \times 5 \times (100 + (5.5 - 5) \times 100 / 5)}{1.225 \times (5.5 - 5) \times 100 / 5} - \frac{511}{(5.5 - 5) \times 100 / 5} - 10.2 = 167.78(k\Omega)$$

The output voltage can also be trimmed by potential applied at the Trim pin.

$$V_o = \frac{(V_{trim} + 1.225) \times V_{norm}}{2.45}$$

Where  $V_{trim}$  is the potential applied at the Trim pin, and  $V_o$  is the desired output voltage. When trimming up, the output current should be decreased accordingly so as not to exceed the maximum output power.

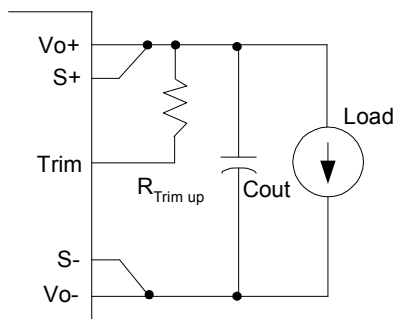

Figure 13 Trim up

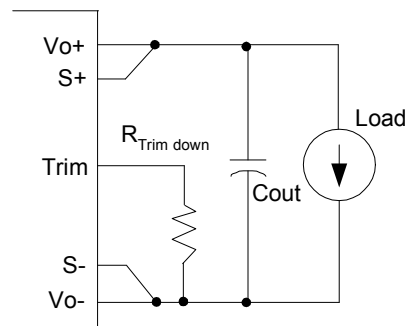

Figure 14 Trim down

### Sense Characteristics

If the load is far from the unit, connect S+ and S- to the terminals of the load respectively to compensate the voltage drop on the transmission line.

If the sense compensation function is not necessary, connect S+ to V<sub>o+</sub> and S- to V<sub>o-</sub> respectively.

## Input Ripple & Inrush Current And Output Ripple & Noise Test Configuration

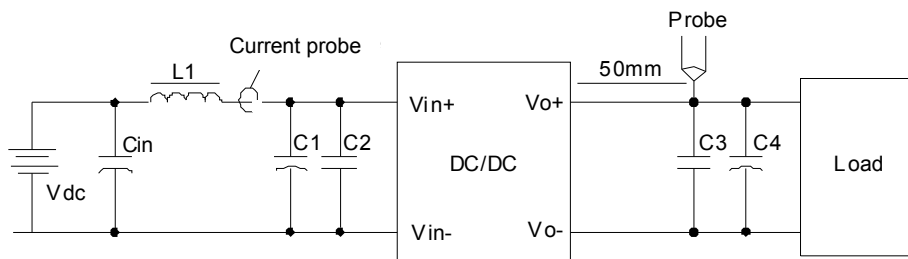

Figure 15 Input ripple & inrush current, ripple & noise test configuration

Vdc: DC power supply

L1: 12μH

Cin: 220μF/100V typical

C1: SMDceramic-100V-100nF-±10%-X7R-1206

C2: 100μF/100V electrolytic capacitor, high frequency and low ESR

C3: SMDceramic-10V-1μF-±10%-X7R-1206

C4: 1000μF/10V electrolytic capacitor, high frequency and low ESR

Note: It is recommended to use a coaxial cable with series 50Ω resistor and 0.68μF ceramic capacitor or a ground ring of probe to test output ripple & noise.

## Recommend EMC Filter Configuration

See Figure11.

## Thermal Considerations

The converter is designed to operate in different thermal environments and sufficient cooling must be provided. Proper cooling can be verified by measuring the temperature at the test points. The temperature at these test points should not exceed the maximum values in Table 1.

For a typical application, forced airflow direction is from Vin- to Vin+, Figure 17 shows the derating of output current vs. ambient air temperature at different air velocity.

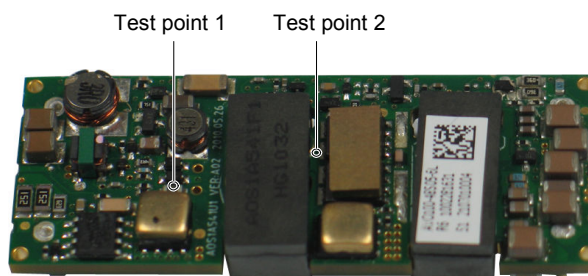

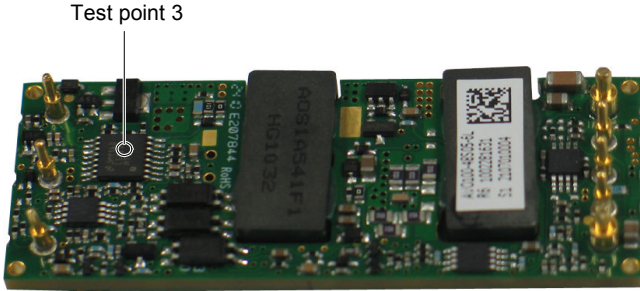

Figure 16 Temperature test point on converter

Table 1 Temperature limits

Test point	Temperature limit
Test point 1	124°C
Test point 2	130°C
Test point 3	118°C

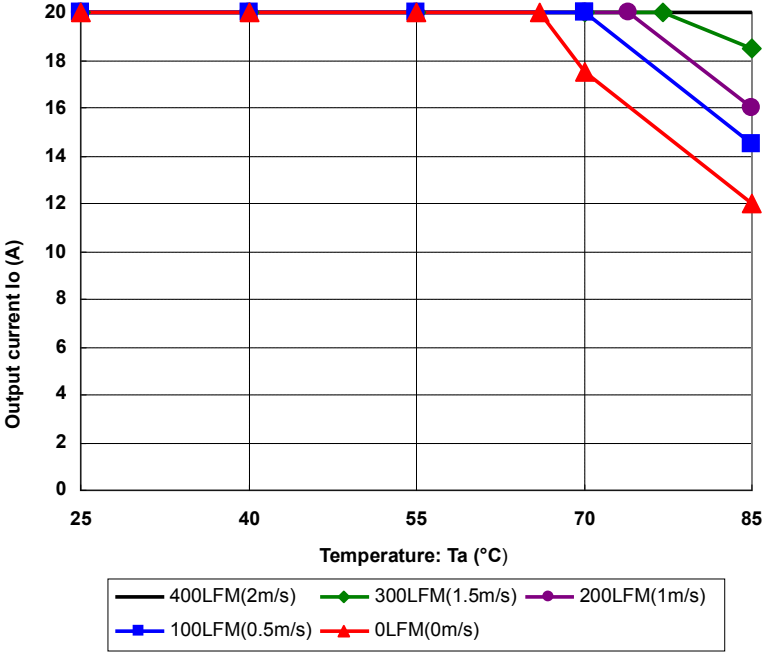

Figure 17 Derating curve

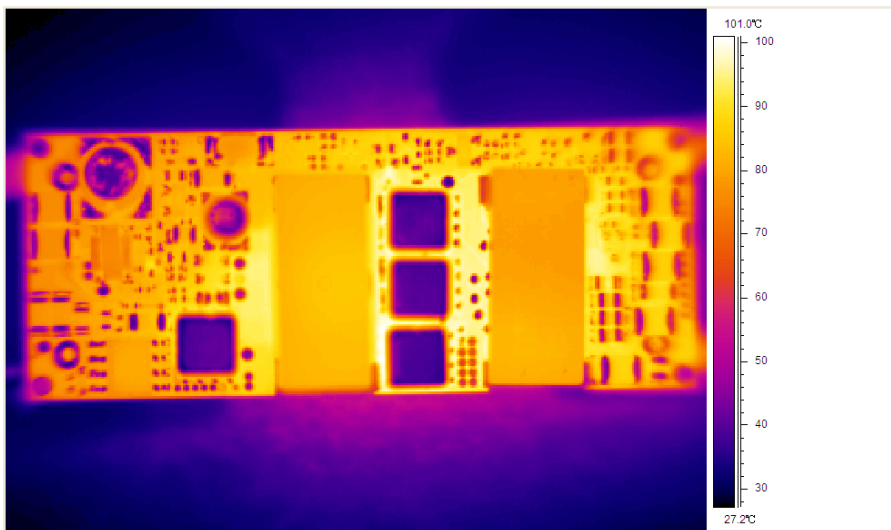
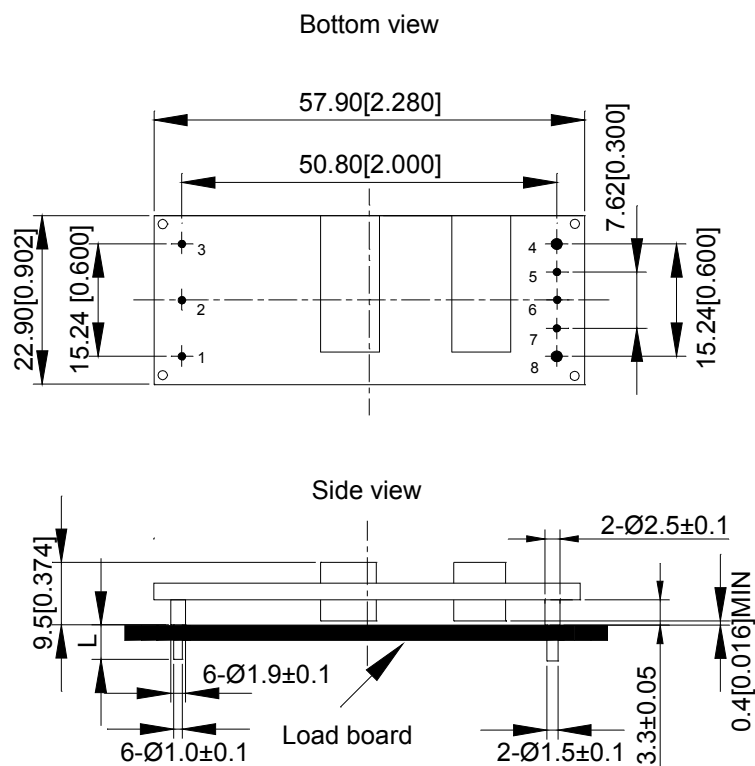

Figure 18 Thermal image, 48V<sub>in</sub>, 5V<sub>o</sub>, full load, room temperature, 100LFM (air flowing from pin 1 to pin 3)

### Mechanical Diagram



Unit: mm [inch] Bottom view: pin on upside

Tolerance: X.Xmm ± 0.5mm [X.X in. ± 0.02in.]  
 X.XXmm ± 0.25mm [X.XX in. ± 0.01in.]

Figure 19 AVO100-48S05 mechanical diagram

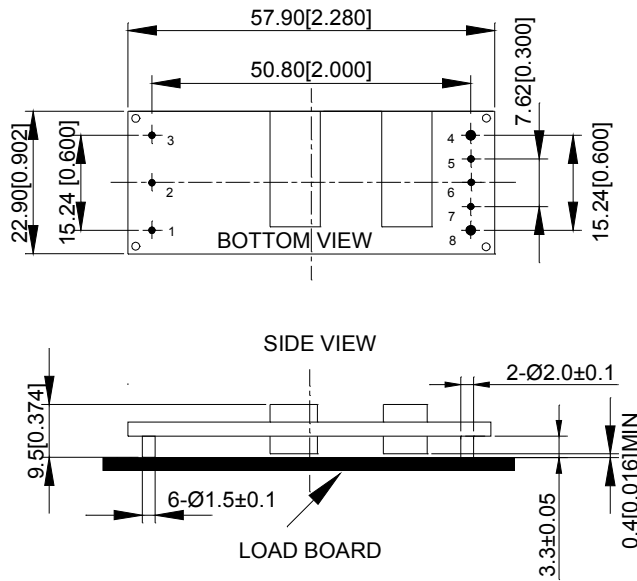

UNIT: mm[inch]                      BOTTOM VIEW: pin on upside  
 TOLERANCE: X.Xmm±0.5mm[X.X in.±0.02in.]  
                   X.XXmm±0.25mm[X.XX in.±0.01in.]

Figure 20 AVO100-48S05SL mechanical diagram

### Recommended Hole Pattern

Through hole with diameter 1.37mm (0.054 inch) is recommended for pin1, pin2, pin3, pin5, pin6 and pin7 soldering. Through hole with diameter 1.88mm (0.074 inch) is for pin4 and pin8. See Figure 21.

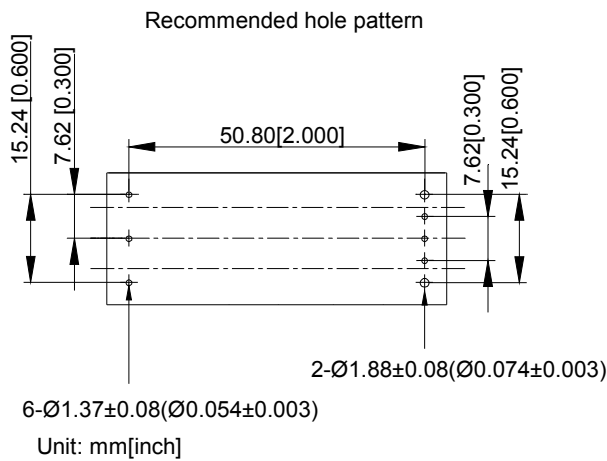

Figure 21 Recommended hole pattern

## Pin Length Option

Device code suffix	L
-4	4.8mm ± 0.2mm
-6	3.8mm ± 0.2mm
-8	2.8mm ± 0.2mm
None	5.8mm ± 0.2mm

## Pin Designations

Pin No.	Name	Function
1	V <sub>in+</sub>	Positive input voltage
2	Remote ON/OFF	Remote control
3	V <sub>in-</sub>	Negative input voltage
4	V <sub>o-</sub>	Negative output voltage
5	S-	Negative remote sense
6	Trim	Output voltage trim
7	S+	Positive remote sense
8	V <sub>o+</sub>	Positive output voltage

## Soldering

The product is intended for standard manual, reflow or wave soldering.

When reflow soldering is used, the temperature on pins is specified to maximum 260°C for maximum 10s.

When wave soldering is used, the temperature on pins is specified to maximum 260°C for maximum 7s.

When soldering by hand, the iron temperature should be maintained at 300°C ~ 380°C and applied to the converter pins for less than 10s. Longer exposure can cause internal damage to the converter.

Cleaning of solder joint can be performed with cleaning solvent IPA or similitive.

## Design Of Surface Mount Solder

- The diameter of pin: 1.5mm (small), 2.0mm (big)
- SMD solder pad: 2.0mm (small), 2.5mm (big)
- The soldermask: 5 mil bigger than the SMD solder pad
- SMD solder pad copper: 3.0mm (small), 3.5mm (big)
- The solder paste: 3.0mm (small), 3.5mm (big)

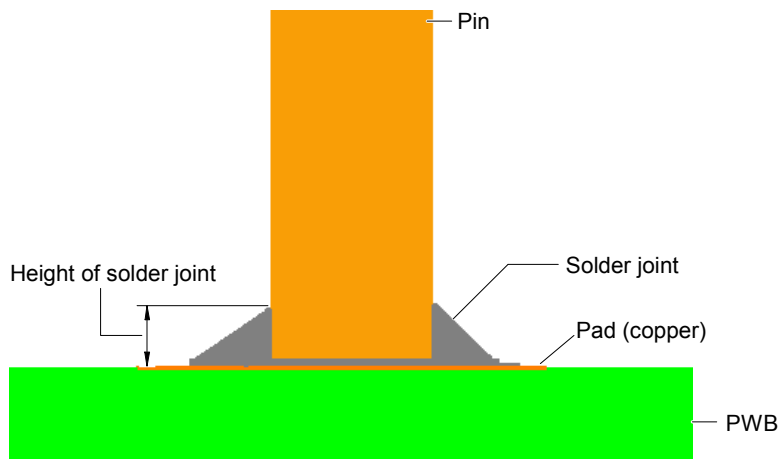

Figure 22 Surface mount solder design

### Package Information

- 1. Package type: moisture sensitivity level 3, moisture barrier bags
- 2. Minimal package QTY: 128 pcs
- 3. Package disassembly

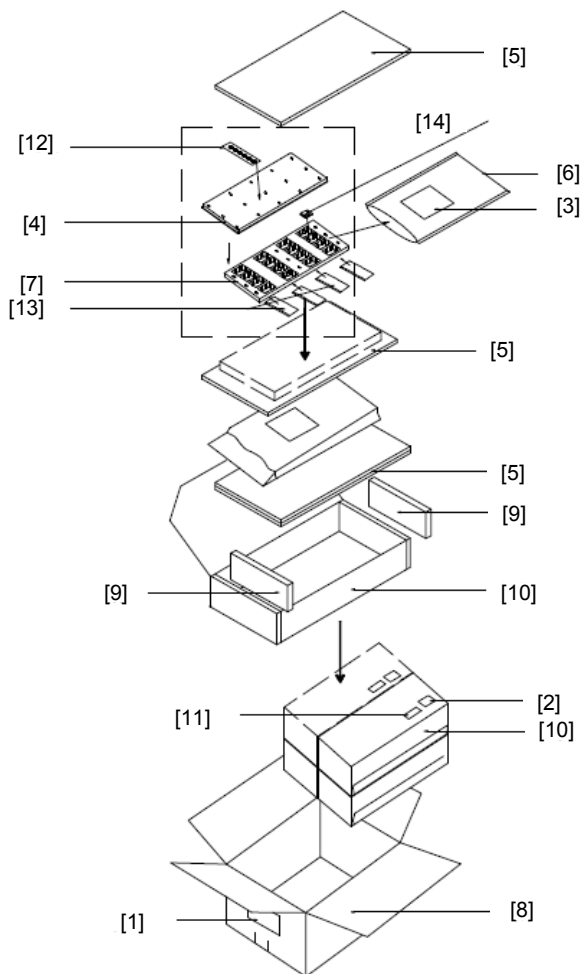

Figure 23 Package disassembly

Table 2 Assemblies description

No.	Description
1	Shipping label
2	Moistureproof identification label
3	Moistureproof caution label
4	Tray cover
5	Anti-static PE foam 1
6	Moisture barrier bag
7	Tray
8	Shipping carton
9	Anti-static PE foam 2
10	Inner box
11	Model barcode label
12	Humidity indicating card
13	Desiccant
14	Model

4. Package tray information

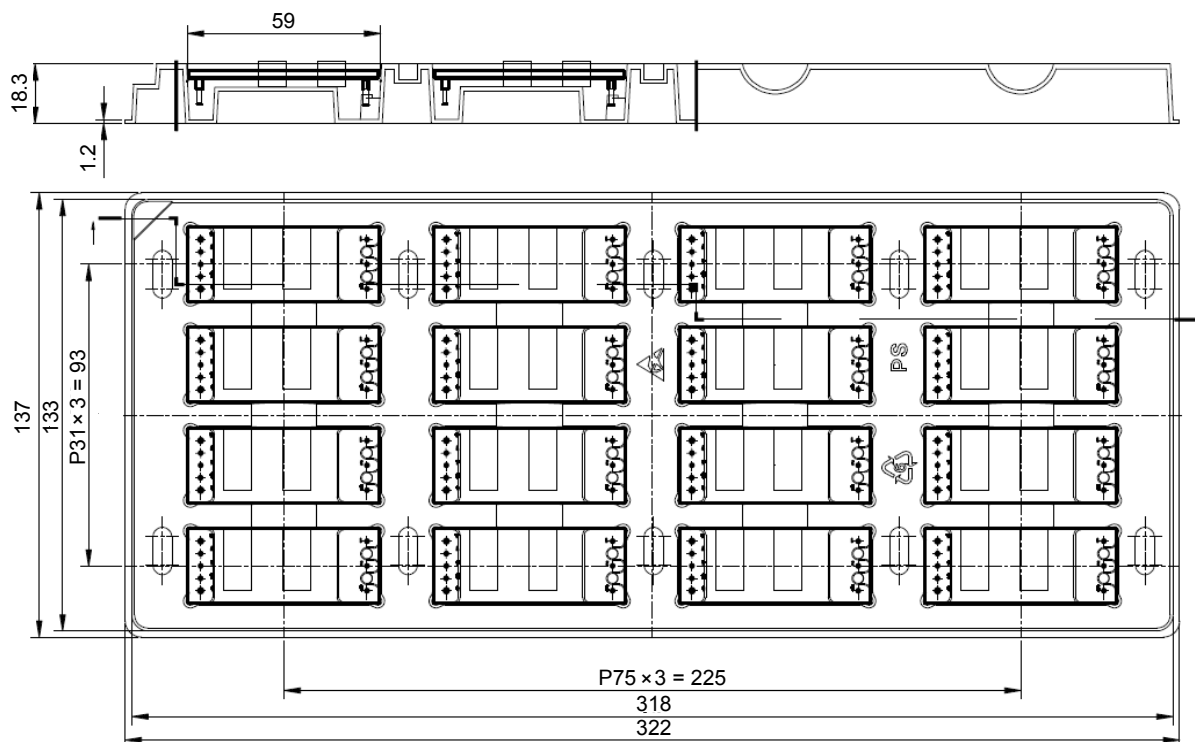

Figure 24 Package tray



### Ordering Information

<b>AVO100</b>	<b>-</b>	<b>48</b>	<b>S</b>	<b>05</b>		<b>-</b>	<b>6</b>	<b>L</b>
①		②	③	④	⑤		⑥	⑦

①	Model series	AVO: standard eighth-brick series, 100: output power 100W
②	Input voltage	48: 36V ~ 75V input range, rated input voltage 48V
③	Output number	S: single output
④	Rated output voltage	05: 5V output
⑤	Remote ON/OFF logic	Default: negative
⑥	Pin length	-6: 3.8mm
⑦	RoHS status	L: RoHS, R6

Model number	Description
AVO100-48S05-6Y	3.8mm pin length; negative on/off logic; without thread inside mounting hole; open frame; R5 compliant
AVO100-48S05P-6Y	3.8mm pin length; positive on/off logic; without thread inside mounting hole; open frame; R5 compliant
AVO100-48S05B-6Y	3.8mm pin length; negative on/off logic; without thread inside mounting hole; with base plate; R5 compliant; see <i>AVO100-48S05B TRN</i>
AVO100-48S05PB-6Y	3.8mm pin length; positive on/off logic; without thread inside mounting hole; with base plate; R5 compliant; see <i>AVO100-48S05B TRN</i>
AVO100-48S05-6L	3.8mm pin length; negative on/off logic; without thread inside mounting hole; open frame; R6 compliant
AVO100-48S05P-6L	3.8mm pin length; positive on/off logic; without thread inside mounting hole; open frame; R6 compliant
AVO100-48S05B-6L	3.8mm pin length; negative on/off logic; without thread inside mounting hole; with base plate; R6 compliant; see <i>AVO100-48S05B TRN</i>
AVO100-48S05PB-6L	3.8mm pin length; positive on/off logic; without thread inside mounting hole; with base plate; R6 compliant; see <i>AVO100-48S05B TRN</i>
AVO100-48S05SL-6L	SMT model; negative on/off logic; open frame, R6 compliant

## Hazardous Substances Announcement (RoHS Of China)

Parts	Hazardous substances					
	Pb	Hg	Cd	Cr <sup>6+</sup>	PBB	PBDE
AVO100-48S05-6L	○	○	○	○	○	○
○: Means the content of the hazardous substances in all the average quality materials of the part is within the limits specified in SJ/T-11363-2006 √: Means the content of the hazardous substances in at least one of the average quality materials of the part is outside the limits specified in SJ/T11363-2006						
Emerson Network Power Co., Ltd. has been committed to the design and manufacturing of environment-friendly products. It will reduce and eventually eliminate the hazardous substances in the products through unremitting efforts in research. However, limited by the current technical level, the following parts still contain hazardous substances due to the lack of reliable substitute or mature solution: <ol style="list-style-type: none"> <li>1. Solders (including high-temperature solder in parts) contain plumbum.</li> <li>2. Glass of electric parts contains plumbum.</li> <li>3. Copper alloy of pins contains plumbum</li> </ol>						