

# SIL40C SERIES

## Single output



Wide trim range (0.9 Vdc to 5.0 Vdc)

Horizontal and vertical models available

High power density design means reduced board space requirement

Remote sense

Power good output signal (open collector)

Operating ambient temperature to 80 °C with suitable de-rating and forced air cooling

Remote ON/OFF (active high)

Overtemperature protection

0 A minimum load

Input undervoltage lockout

Overcurrent and short-circuit protection

Current sharing option

Available RoHS compliant

The SIL40C is a new high density open-frame non-isolated converter series for space sensitive applications. The converter has a wide input range (10.2 Vdc to 13.8 Vdc) and offers a wide 0.9 Vdc to 5 Vdc output voltage range with a 40 A load. An external resistor adjusts the output voltage from its preset value of 0.9 V to any value up to the 5 V maximum. The SIL has a typical efficiency of 92%. The series offers remote ON/OFF, overtemperature protection and overcurrent protection as standard.

Its current share facility supports parallel operation of multiple SIL40C units and the remote sense feature enables the SIL40C compensate for voltage drops between the converters output and the load. With full international safety approvals including EN60950 and UL/cUL60950 the SIL40C reduces compliance costs and time to market.

[ 2 YEAR WARRANTY ]



**ARTESYN**<sup>®</sup>  
TECHNOLOGIES

**Absolute Maximum Ratings**

Characteristic	Symbol	Min	Typ	Max	Units	Notes and Conditions
Input voltage - continuous	$V_{in} (cont)$	-0.3		13.8	V DC	$V_{in(+)} - V_{in(-)}$
Operating temperature	$T_{op}$	0		80	°C	Measured at thermal reference points, see Note 1. Higher ambient operation possible with forced air cooling. See de-rating curves
Power good pull-up voltage				11	V	
Storage temperature	$T_{storage}$	-40		125	°C	
Output current	$I_{out}$	0		40	A	

All specifications are typical at nominal input  $V_{in} = 12V$ , full load under any resistive load combination at 25°C unless otherwise stated.

**Input Characteristics**

Characteristic	Symbol	Min	Typ	Max	Units	Notes and Conditions
Input voltage - operating	$V_{in} (oper)$	10.2	12.0	13.8	V DC	
Input current - no load	$I_{in}$		290		mADC	$V_{in} (min) - V_{in} (max)$ , enabled
Input current - Quiescent	$I_{in} (off)$		30		mADC	Converter disabled
Input voltage variation	$dv/dt$		1.0		V/ms	Product was tested at 1.2V/ms. Much higher $dv/dt$ is possible (>10V/ms). Consult factory for details

**Turn On/Off**

Characteristic	Symbol	Min	Typ	Max	Units	Notes and Conditions
Input voltage - turn on	$V_{in} (on)$	8.5	9.0	9.5	V DC	
Input voltage - turn off	$V_{in} (off)$	7.1	7.6	8.1	V DC	
Turn on delay - enabled, then power applied	$T_{delay} (power)$			30	msec	With the Remote ON/OFF signal asserted, this is the time from when the input voltage reaches the minimum specified operating voltage until the POWER GOOD is asserted high
Turn on delay - power applied, then Remote ON/OFF asserted	$T_{delay} (Remote ON/OFF)$			30	msec	$V_{in} = V_{in} (nom)$ , then Remote ON/OFF asserted. This is the time taken until the POWER GOOD is asserted high
Output to Power Good delay	$T_{delay}$			8	msec	Output voltage in full regulation to POWER GOOD asserted high
Rise time	$T_{rise}$		3		msec	From 10% to 90%; full resistive load, 2 x 680µF external capacitance

## Signal Electrical Interface

Characteristic - Signal Name	Symbol	Min	Typ	Max	Units	Notes and Conditions
<b>At remote/control ON/OFF pin</b> Open collector or equivalent compatible						<b>See Notes 2 and 3</b> See Application Note 132 for Remote ON/OFF details
Control pin open circuit voltage	$V_{ih}$		2.27	2.50	V	$I_{ih} = 0 \mu\text{A}$ ; open circuit voltage
High level input current	$I_{ih}$			1	$\mu\text{A}$	Current flowing into control pin when pin is pulled high (max. at $V_{ih} = 13.8\text{V}$ )
High level input voltage	$V_{ih}$	2.40			Vin	Converter guaranteed on when control pin is greater than $V_{ih}$ (max)
Low level input voltage	$V_{il}$			0.80	V	Converter guaranteed off when control pin is less than $V_{il}$ (max)
Low level input current	$I_{il}$ (max)			1.3	mA	$V_{il} = 0.0 \text{V}$ ;

## Reliability and Service Life

Characteristic	Symbol	Min	Typ	Max	Units	Notes and Conditions
Mean time between failure	MTBF	95,418			Hours	MIL-HDBK-217F, $V_{in} = V_{in}$ (nom); $I_{out} = I_{out}$ (max); ambient 25°C; ground benign environment
Mean time between failure	MTBF	4,585,991			Hours	Telcordia SR-332 Issue 3, ground benign, temp. = 40°C, $V_{in} = V_{in}$ (nom), $I_{out} = I_{out}$ (max)

## Other Specifications

Characteristic	Symbol	Min	Typ	Max	Units	Notes and Conditions
Switching frequency	$F_{sw}$		300		kHz	Fixed frequency
Weight			28.3		g	

## Safety Agency Approvals

Characteristic	
UL/cUL 60950	File No. E139421
TÜV Product Service IEC 60950	Certificate No. B 03 08 19870 219

## Material Ratings

Characteristic - Signal Name	Notes and Conditions
Flammability rating	UL94V-0
Material type	FR4 PCB

## Model Numbers

Model Number (See Notes below)	Input Voltage	Output Voltage	Output Current (Max.)	Typical Efficiency	Max. Load Regulation
SIL40C-12SADJ-VJ	12VDC	0.9 - 5.0V	40A	92%	±1.5%
SIL40C-12SADJ-VSJ	12VDC	0.9 - 5.0V	40A	92%	±1.5%
SIL40C-12SADJ-HJ	12VDC	0.9 - 5.0V	40A	92%	±1.5%
SIL40C-12SADJ-HSJ	12VDC	0.9 - 5.0V	40A	92%	±1.5%

## Suffix Notes:

Suffix '-V' and suffix '-H' are to be used for non-isolated current sharing applications.  
 Suffix '-VS' and suffix '-HS' are to be used for isolated current sharing applications.

## RoHS Compliance Ordering Information



The 'J' at the end of the part number indicates that the part is Pb-free (RoHS 6/6 compliant). TSE RoHS 5/6 (non Pb-free) compliant versions may be available on special request, please contact your local sales representative for details.

## 0.9V Setpoint

## Input Characteristics

Characteristic	Symbol	Min	Typ	Max	Units	Notes and Conditions
Input current - operating	$I_{in}$		4.40		A DC	$V_{in} = V_{in} (nom)$ ; $I_{out} = I_{out} (max.)$
Reflected ripple current	$I_{in} (ripple)$		27 62		mA RMS mA pk-pk	$I_{out} = I_{out} (max.)$ , measured with external filter. See Application Note 132 for details
Input capacitance - internal filter	$C_{input}$		18.8		$\mu F$	
Input capacitance - external external input	$C_{bypass}$		270		$\mu F$	Recommended customer added capacitance. Maximum ESR = 20m $\Omega$ See Application Note 132 for ripple current requirements

## 0.9V Setpoint

## Electrical Characteristics - O/P

Characteristic	Symbol	Min	Typ	Max	Units	Notes and Conditions
Nominal set-point voltage	$V_o (nom)$	0.873	0.900	0.927	V DC	$V_{in} = V_{in} (nom)$ ; $I_{out} = I_{out} (NL)$
Line regulation				0.2	%	$V_{in} (min)$ to $V_{in} (max)$
Load regulation				1.5	%	$V_{in} = V_{in} (nom)$ ; $I_{out} (min)$ to $I_{out} (max)$
Output current continuous	$I_{out}$	0		40	A DC	
Output current - short circuit	$I_{sc}$		22.5		A rms	Continuous, unit auto recovers from short, $V_o < 100mV$
Output voltage - noise	$V_{p-p}$ $V_{rms}$			40 15	mV pk-pk mV rms	Measurement bandwidth 20 MHz See Application Note 132 for measurement set-up details
Current sharing			$\pm 10$		%	$I_{out} = I_{out} (max)$

## 0.9V Setpoint

## Electrical Characteristics - O/P

Characteristic	Symbol	Min	Typ	Max	Units	Notes and Conditions
Load transient response - peak deviation	$V_{dynamic}$		55		mV	Peak deviation for 50% to 75% step load, $di/dt = 10A/\mu sec$
Load transient response - recovery	$T_{recovery}$		30		$\mu sec$	Settling time to within 1% of output set point voltage for 50% to 75% step load
External load capacitance	$C_{ext}$		2,040		$\mu F$	Maximum capacitor value may vary with load conditions. Consult factory for details Max ESR = 12m $\Omega$ See Application Note 132 for output capacitance values vs. stability

## 0.9V Setpoint

## Protection and Control Features

Characteristic	Symbol	Min	Typ	Max	Units	Notes and Conditions
Overcurrent limit inception	$I_{oc}$		62		A DC	$V_o = 90\%$ of $V_o$ (nom)
Open sense voltage			0.9		V DC	Sense pins not connected

## 0.9V Setpoint

## Efficiency

Characteristic	Symbol	Min	Typ	Max	Units	Notes and Conditions
Efficiency	$\eta$	69.8	71.8		%	$I_{out} = 100\% I_{out} (max)$ , $V_{in} = V_{in} (nom)$
Efficiency	$\eta$	75.3	77.3		%	$I_{out} = 50\% I_{out} (max)$ , $V_{in} = V_{in} (nom)$

## 2.5V Setpoint

## Input Characteristics

Characteristic	Symbol	Min	Typ	Max	Units	Notes and Conditions
Input current - operating	$I_{in}$		9.85		A DC	$V_{in} = V_{in} (nom)$ ; $I_{out} = I_{out} (max.)$
Reflected ripple current	$I_{in} (ripple)$		45 105		mA RMS mA pk-pk	$I_{out} = I_{out} (max.)$ , measured with external filter. See Application Note 132 for details
Input capacitance - internal filter	$C_{input}$		18.80		$\mu F$	
Input capacitance - external external input	$C_{bypass}$		270		$\mu F$	Recommended customer added capacitance. Maximum ESR = 20m $\Omega$ See Application Note 132 for ripple current requirements

## 2.5V Setpoint

## Electrical Characteristics - O/P

Characteristic	Symbol	Min	Typ	Max	Units	Notes and Conditions
Nominal set-point voltage	$V_o (nom)$	2.425	2.500	2.575	V DC	$V_{in} = V_{in} (nom)$ ; $I_{out} = I_{out} (NL)$
Line regulation				$\pm 0.2$	%	$V_{in} (min)$ to $V_{in} (max)$
Load regulation				$\pm 1$	%	$V_{in} = V_{in} (nom)$ ; $I_{out} (min)$ to $I_{out} (max)$
Output current continuous	$I_{out}$	0		40	A DC	
Output current - short circuit	$I_{sc}$		23.9		A rms	Continuous, unit auto recovers from short, $V_o < 100mV$
Output voltage - noise	$V_{p-p}$ $V_{rms}$			50 15	mV pk-pk mV rms	Measurement bandwidth 20 MHz See Application Note 132 for measurement set-up details
Current sharing			$\pm 10$		%	$I_{out} = I_{out} (max)$

## 2.5V Setpoint

## Electrical Characteristics - O/P

Characteristic	Symbol	Min	Typ	Max	Units	Notes and Conditions
Load transient response - peak deviation	$V_{dynamic}$		55		mV	Peak deviation for 50% to 75% step load, $di/dt = 10A/\mu sec$
Load transient response - recovery	$T_{recovery}$		30		$\mu sec$	Settling time to within 1% of output set point voltage for 50% to 75% step load
External load capacitance	$C_{ext}$		2,040		$\mu F$	Maximum capacitor value may vary with load conditions. Consult factory for details Max ESR = 12m $\Omega$ See Application Note 132 for output capacitance values vs. stability

## 2.5V Setpoint

## Protection and Control Features

Characteristic	Symbol	Min	Typ	Max	Units	Notes and Conditions
Overcurrent limit inception	$I_{oc}$		62		A DC	$V_o = 90\%$ of $V_o$ (nom)
Open sense voltage			2.5		V DC	Sense pins not connected

## 2.5V Setpoint

## Efficiency

Characteristic	Symbol	Min	Typ	Max	Units	Notes and Conditions
Efficiency	$\eta$	83.7	85.7		%	$I_{out} = 100\% I_{out} (max)$ , $V_{in} = V_{in} (nom)$
Efficiency	$\eta$	87.0	89.0		%	$I_{out} = 50\% I_{out} (max)$ , $V_{in} = V_{in} (nom)$



## 5V Setpoint

## Input Characteristics

Characteristic	Symbol	Min	Typ	Max	Units	Notes and Conditions
Input current - operating	$I_{in}$		18.15		A DC	$V_{in} = V_{in} (nom)$ ; $I_{out} = I_{out} (max.)$
Reflected ripple current	$I_{in} (ripple)$		41 115		mA RMS mA pk-pk	$I_{out} = I_{out} (max.)$ , measured with external filter. See Application Note 132 for details
Input capacitance - internal filter	$C_{input}$		18.8		$\mu F$	
Input capacitance - external external input	$C_{bypass}$		270		$\mu F$	Recommended customer added capacitance. Maximum ESR = 20m $\Omega$ See Application Note 132 for ripple current requirements

## 5V Setpoint

## Electrical Characteristics - O/P

Characteristic	Symbol	Min	Typ	Max	Units	Notes and Conditions
Nominal set-point voltage	$V_o (nom)$	4.85	5.000	5.15	V DC	$V_{in} = V_{in} (nom)$ ; $I_{out} = I_{out} (NL)$
Line regulation				$\pm 0.2$	%	$V_{in} (min)$ to $V_{in} (max)$
Load regulation				$\pm 1$	%	$V_{in} = V_{in} (nom)$ ; $I_{out} (min)$ to $I_{out} (max)$
Output current continuous	$I_{out}$	0		40	A DC	
Output current - short circuit	$I_{sc}$			23.9	A rms	Continuous, unit auto recovers from short, $V_o < 100mV$
Output voltage - noise	$V_{p-p}$ $V_{rms}$			50 15	mV pk-pk mV rms	Measurement bandwidth 20 MHz See Application Note 132 for measurement set-up details
Current sharing			$\pm 10$		%	$I_{out} = I_{out} (max)$

## 5V Setpoint

## Electrical Characteristics - O/P

Characteristic	Symbol	Min	Typ	Max	Units	Notes and Conditions
Load transient response - peak deviation	$V_{dynamic}$		55		mV	Peak deviation for 50% to 75% step load, $di/dt = 10A/\mu sec$
Load transient response - recovery	$T_{recovery}$		40		$\mu sec$	Settling time to within 1% of output set point voltage for 50% to 75% step load
External load capacitance	$C_{ext}$		2,040		$\mu F$	Maximum capacitor value may vary with load conditions. Consult factory for details Max ESR = 12m $\Omega$ See Application Note 132 for output capacitance values vs. stability

## 5V Setpoint

## Protection and Control Features

Characteristic	Symbol	Min	Typ	Max	Units	Notes and Conditions
Overcurrent limit inception	$I_{oc}$		62		A DC	$V_O = 90\%$ of $V_O (nom)$
Open sense voltage			5		V DC	Sense pins not connected

## 5V Setpoint

## Efficiency

Characteristic	Symbol	Min	Typ	Max	Units	Notes and Conditions
Efficiency	$\eta$	90.2	92.2		%	$I_{out} = 100\% I_{out (max)}$ , $V_{in} = V_{in (nom)}$
Efficiency	$\eta$	91.7	93.7		%	$I_{out} = 50\% I_{out (max)}$ , $V_{in} = V_{in (nom)}$

0.9V Model

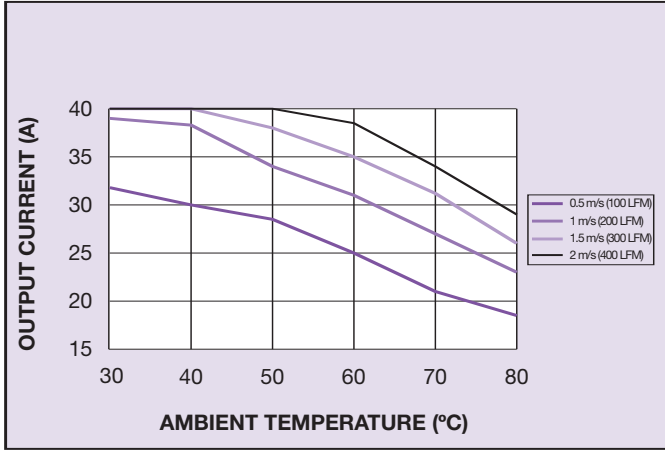

Figure 1: Thermal De-rating Curve

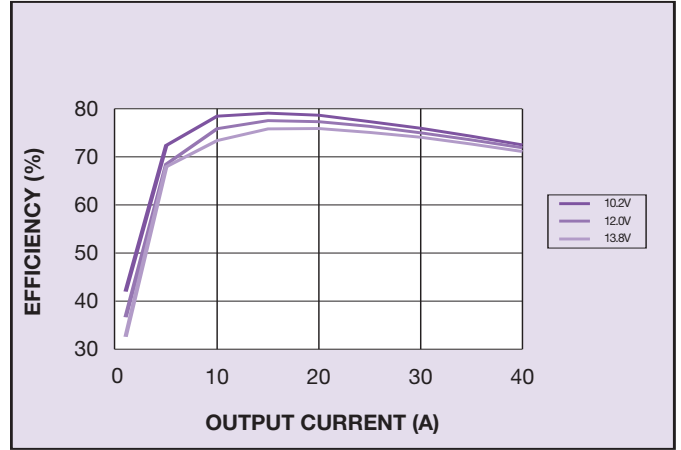

Figure 2: Efficiency vs Load and Line

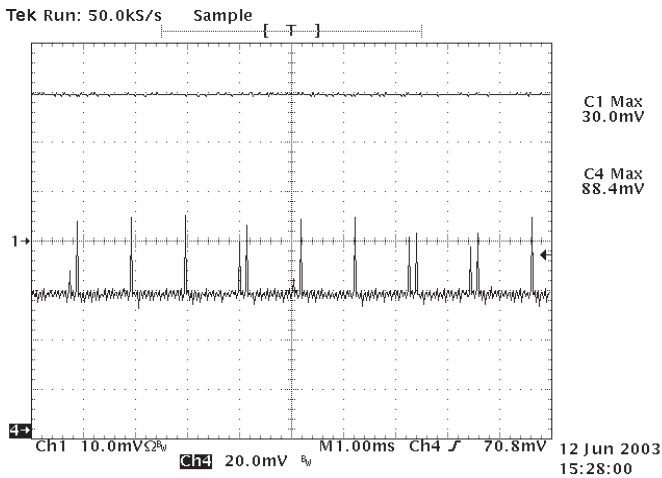

Figure 3: Short Circuit Characteristic (Channel 1: Output Current at 10A/div, Channel 4: Output Voltage)

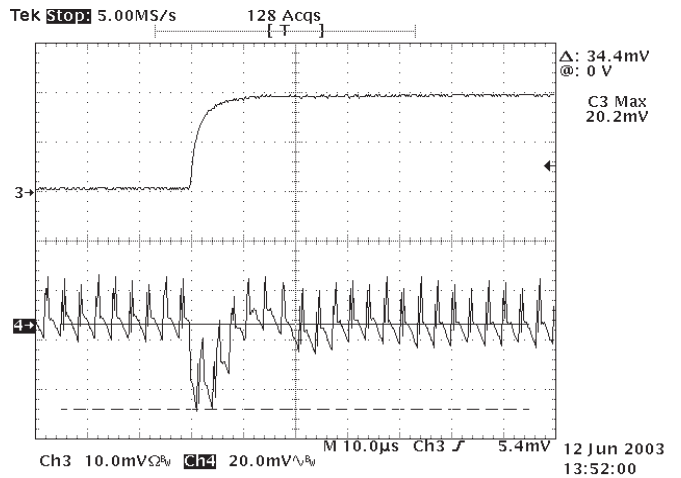

Figure 4: Transient Response 50-75% (Channel 3: Current load step at 5A/div, Channel 4: Output Voltage deviation)

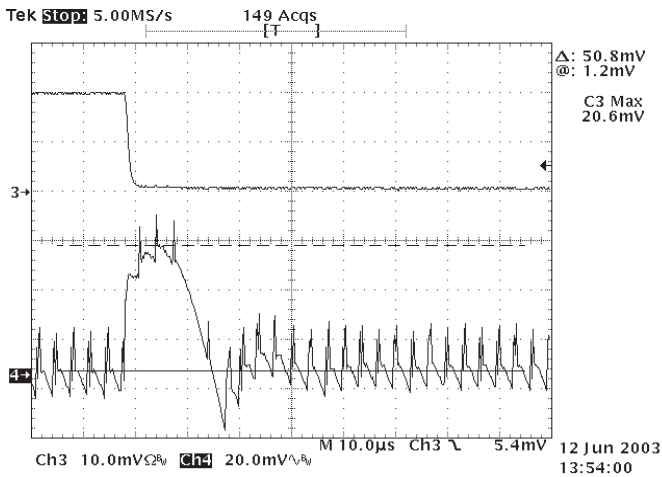

Figure 5: Transient Response 75 - 50% (Channel 3: Current load step at 5A/div, Channel 4: Output Voltage deviation)

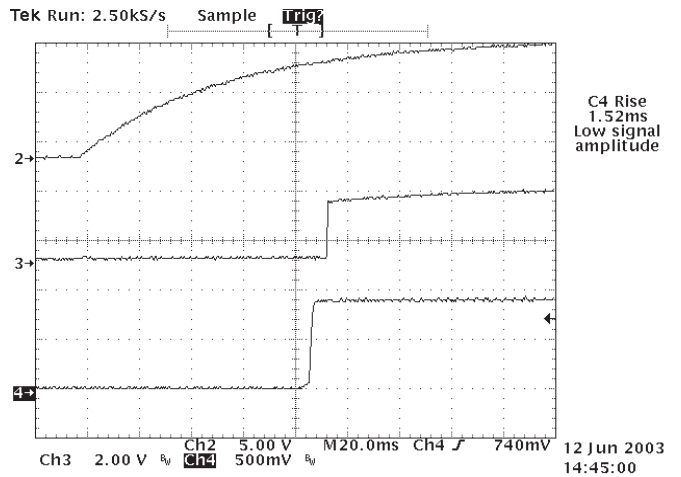

Figure 6: Typical Power Up (Channel 2: DC Input, Channel 3: Power Good Channel 4: Output Voltage)

0.9V Model

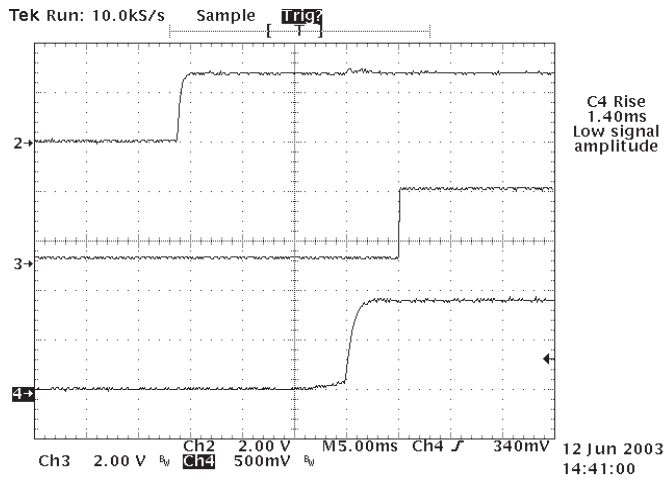

Figure 7: Control On/Off  
 (Channel 2: Remote ON/OFF, Channel 3: Power Good  
 Channel 4: Output Voltage)

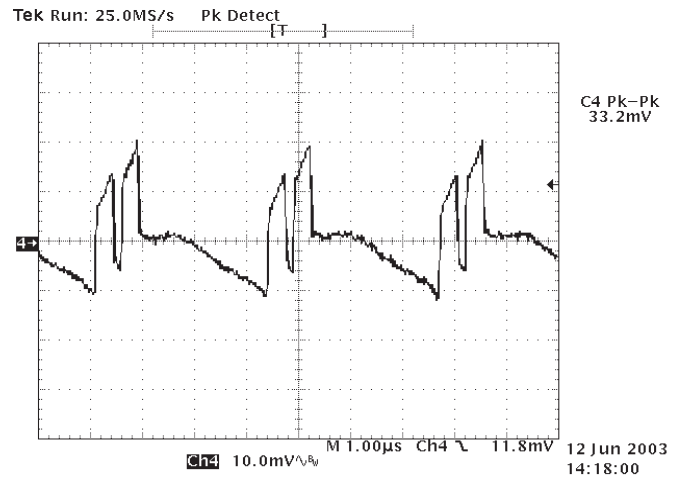

Figure 8: Typical Ripple and Noise

2.5V Model

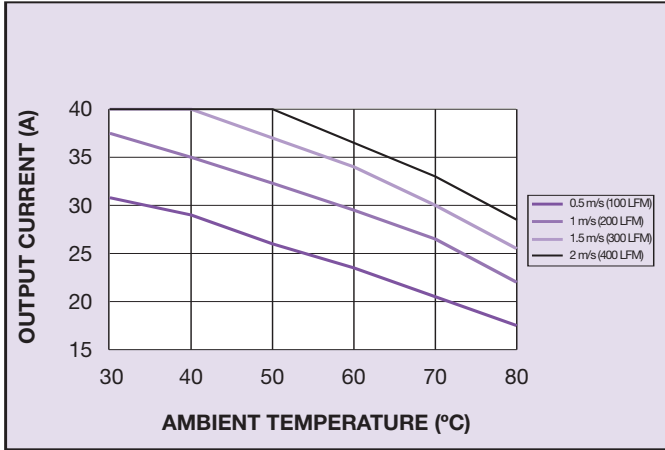

Figure 9: Thermal De-rating Curve

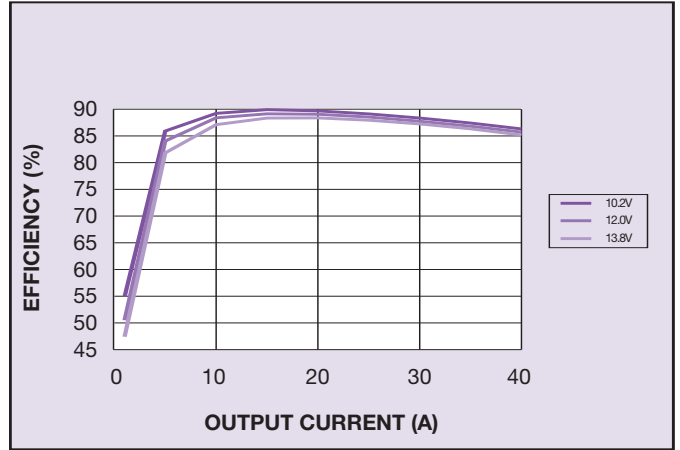

Figure 10: Efficiency vs Load and Line

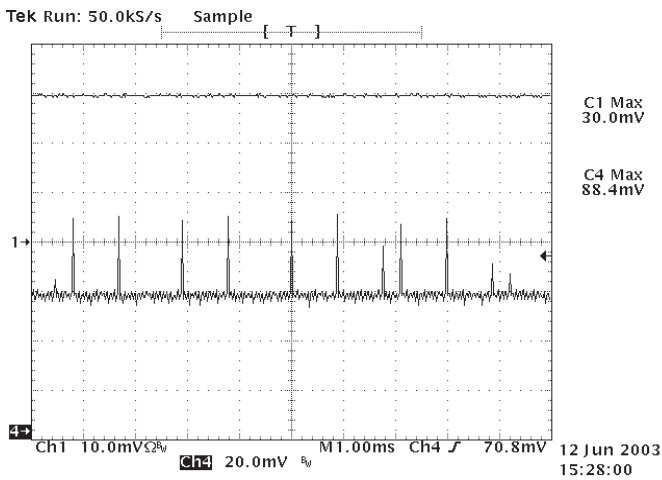

Figure 11: Short Circuit Characteristic  
(Channel 1: Output Current at 10A/div,  
Channel 4: Output Voltage)

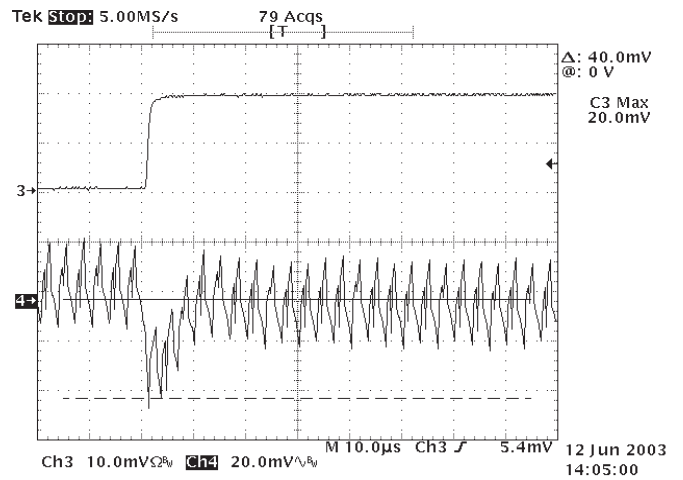

Figure 12: Transient Response 50-75%  
(Channel 3: Current load step at 5A/div,  
Channel 4: Output Voltage deviation)

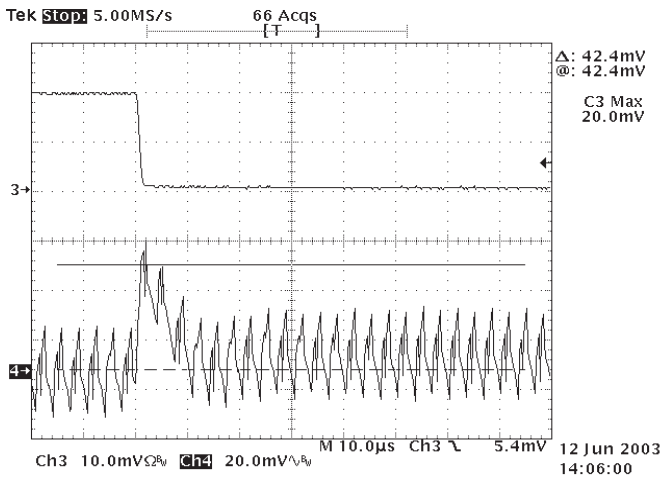

Figure 13: Transient Response 75 - 50%  
(Channel 3: Current load step at 5A/div,  
Channel 4: Output Voltage deviation)

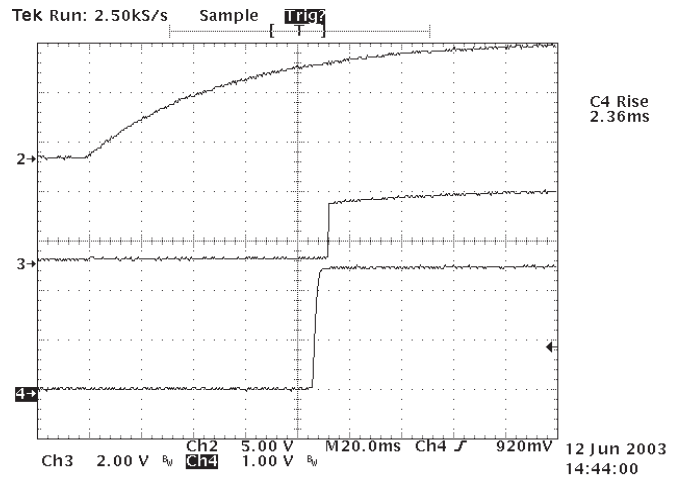

Figure 14: Typical Power Up  
(Channel 2: DC Input, Channel 3: Power Good  
Channel 4: Output Voltage)

2.5V Model

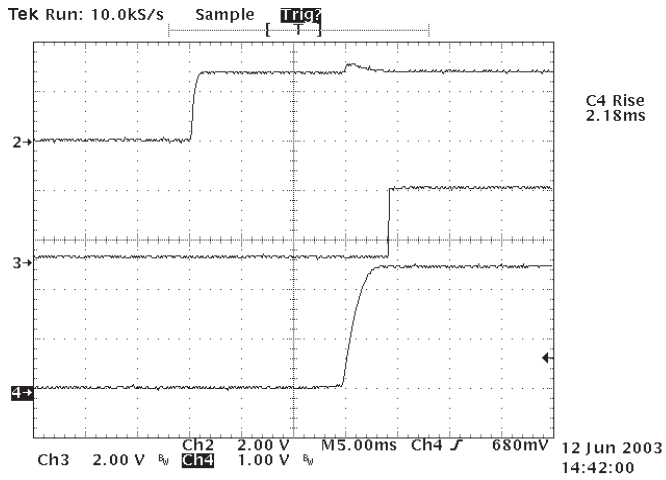

Figure 15: Control On/Off  
 (Channel 2: Remote ON/OFF, Channel 3: Power Good  
 Channel 4: Output Voltage)

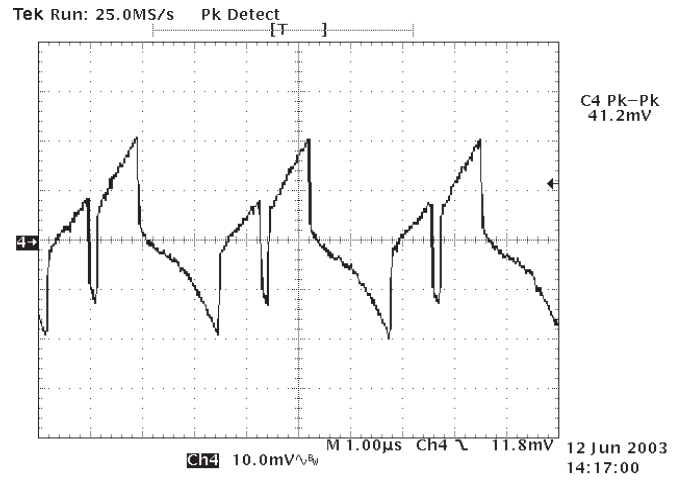

Figure 16: Typical Ripple and Noise

5V Model

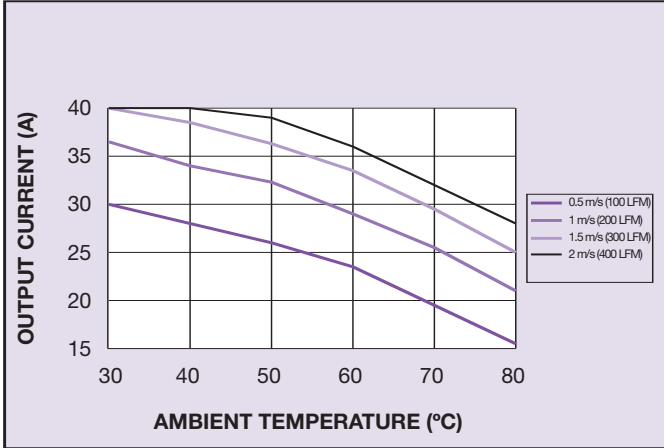

Figure 17: Thermal De-rating Curve

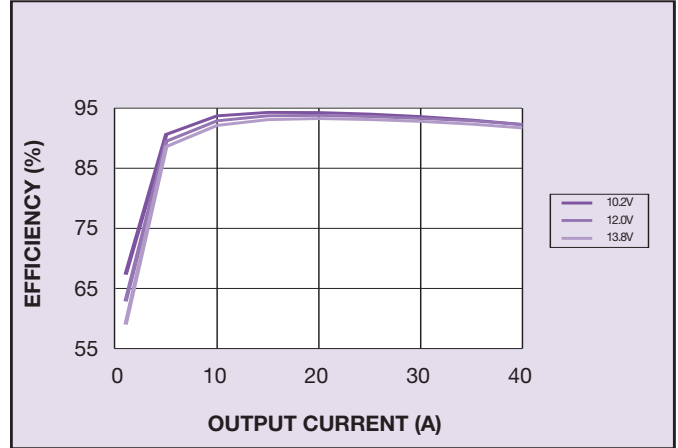

Figure 18: Efficiency vs Load and Line

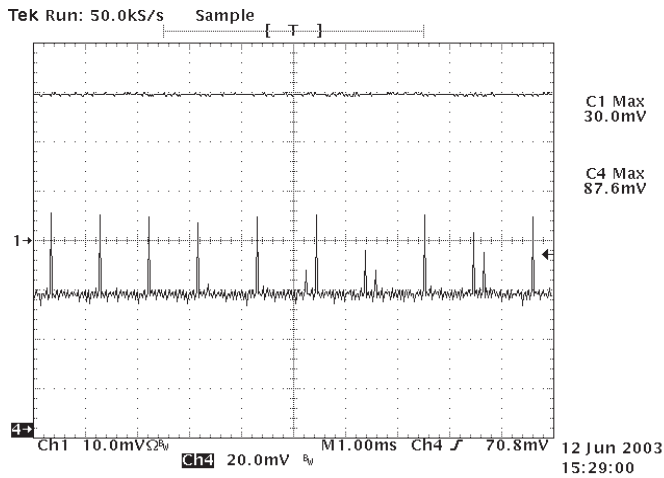

Figure 19: Short Circuit Characteristic (Channel 1: Output Current at 10A/div, Channel 4: Output Voltage)

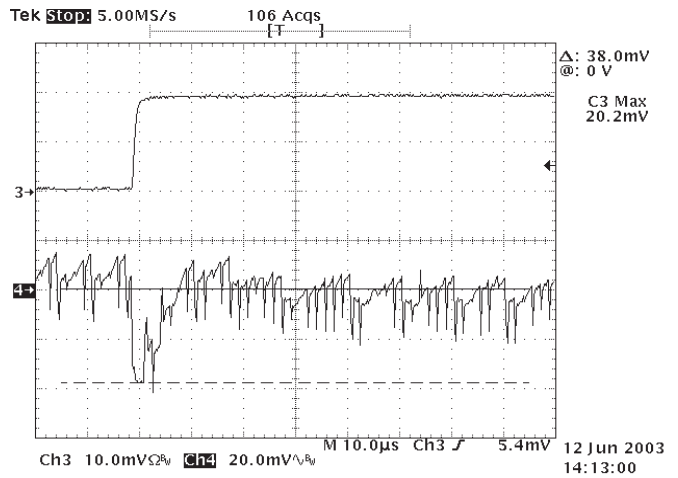

Figure 20: Transient Response 50-75% (Channel 3: Current load step at 5A/div, Channel 4: Output Voltage deviation)

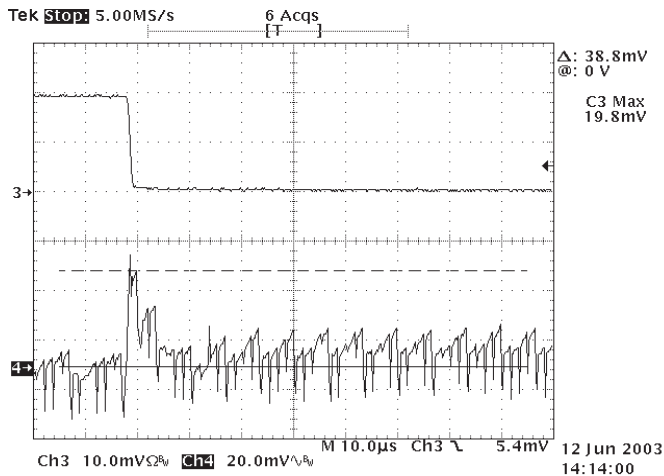

Figure 21: Transient Response 75 - 50% (Channel 3: Current load step at 5A/div, Channel 4: Output Voltage deviation)

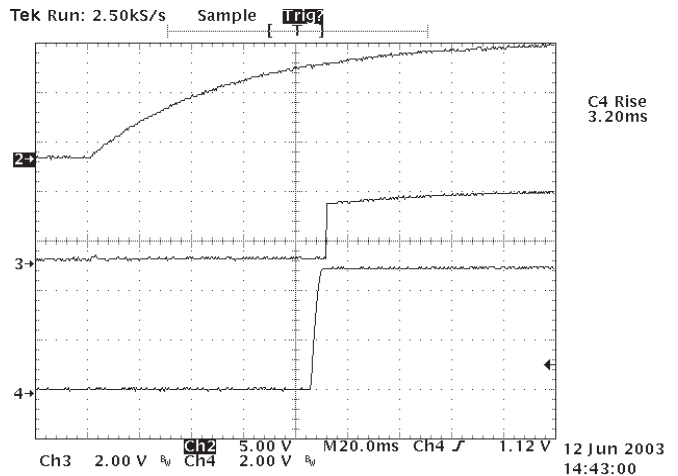

Figure 22: Typical Power Up (Channel 2: DC Input, Channel 3: Power Good Channel 4: Output Voltage)

5V Model

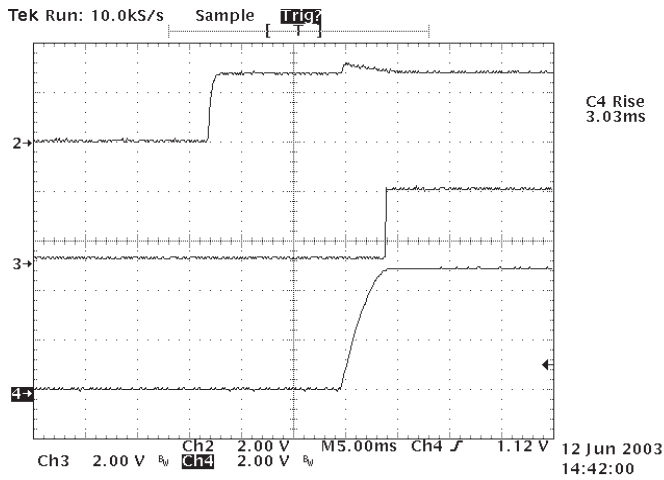

Figure 23: Control On/Off  
 (Channel 2: Remote ON/OFF, Channel 3: Power Good  
 Channel 4: Output Voltage)

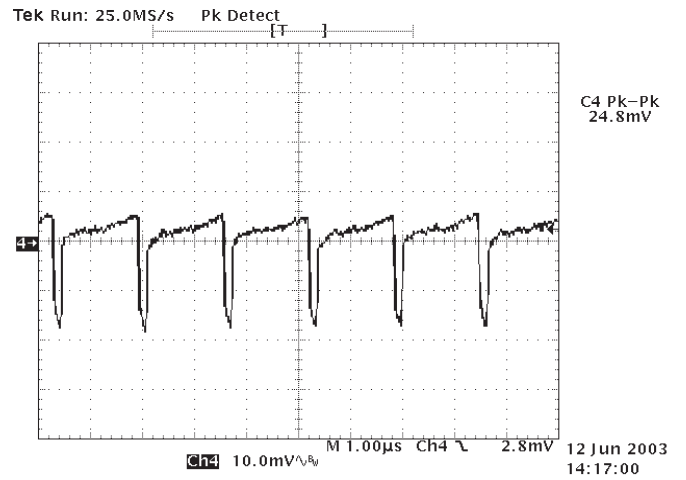

Figure 24: Typical Ripple and Noise



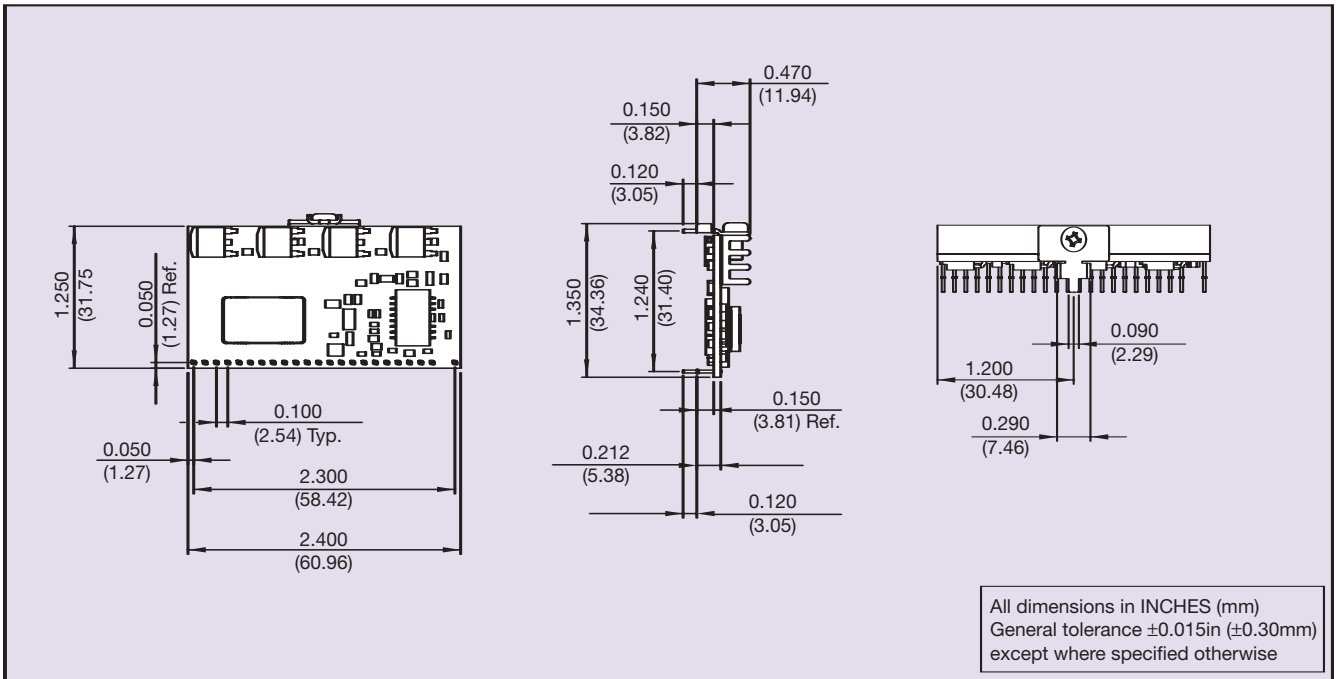

Figure 25: Mechanical Drawing - Horizontal

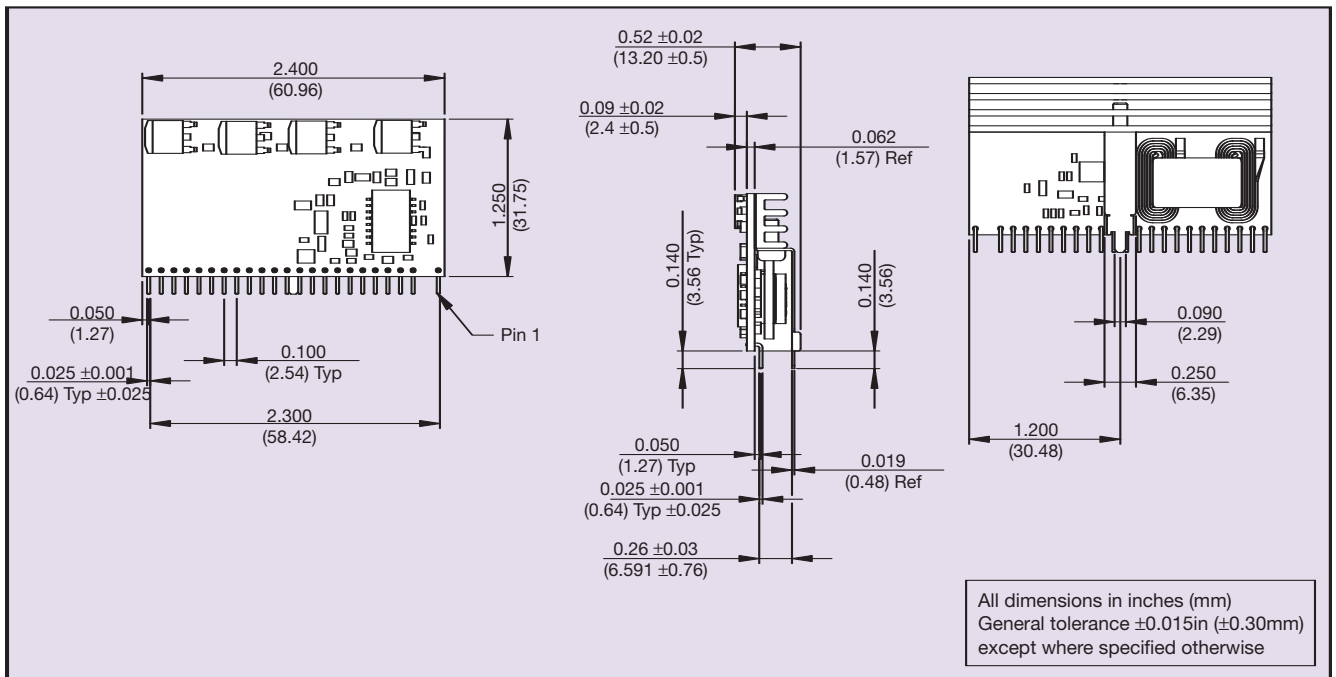

Figure 26: Mechanical Drawing - Vertical

**Note 1**

Thermal reference point is defined as the highest temperature measured at any one of the specified thermal reference points. See Figure 19: Thermal reference point.

**Note 2**

The control pin is referenced to Vin-

**Note 3**

The SIL40C is supplied as standard with active High logic.  
 Control input pulled low: Unit Disabled  
 Control input left open: Unit Enabled

**Note 4**

Thermal reference set up: Unit mounted on an edge card test board 215mm x 115mm. Test board mounted vertically. For test details and recommended set-up see Application Note 132 .

**Note 5**

3-200Hz, sweep at 1/2 octave/min from low to high frequency, and then from high to low. Thirty minute dwell at all resonant points.

**CAUTION:** Hazardous internal voltages and high temperatures. Ensure that unit is accessible only to trained personnel. The user must provide the recommended fusing in order to comply with safety approvals.

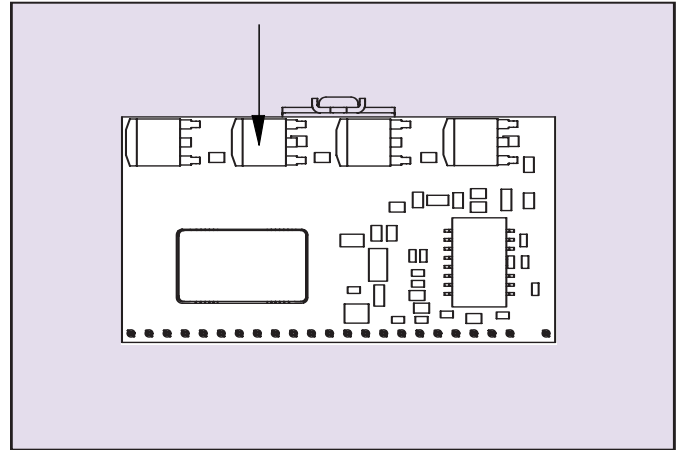

Figure 27: Thermal reference points

Pin Connections	
Pin No.	Function
1	TRIM
2	No Pin
3	Ground
4	POWER GOOD
5	Not Connected
6	Current Share
7	Ground
8	Ground
9	Remote ON/OFF
10	Remote Sense (GND)
11	Remote Sense (O/P)
12	Vin
13	Vin
14	Vin
15	Vout
16	Vout
17	Ground
18	Vout
19	Ground
20	Vout
21	Ground
22	Vout
23	Ground
24	Vout

Figure 28: Dimensions and Pinout

**NORTH AMERICA**e-mail: [sales.us@arteesyn.com](mailto:sales.us@arteesyn.com)

☎ 800 769 7274

☎ +508 628 5600

**EUROPEAN LOCATIONS**e-mail: [sales.europe@arteesyn.com](mailto:sales.europe@arteesyn.com)**IRELAND**

☎ +353 24 93130

**AUSTRIA**

☎ +43 1 80150

**FAR EAST LOCATIONS**e-mail: [sales.asia@arteesyn.com](mailto:sales.asia@arteesyn.com)**HONG KONG**

☎ +852 2699 2868

Longform Datasheet © Artesyn Technologies® 2005

The information and specifications contained in this datasheet are believed to be correct at time of publication. However, Artesyn Technologies accepts no responsibility for consequences arising from printing errors or inaccuracies. Specifications are subject to change without notice. No rights under any patent accompany the sale of any such product(s) or information contained herein.