

APC18T04 Series: 3.0-5.5Vin / 18A Non-Isolated Point-of-Load

The APC18 DC-DC Power Module is a high efficiency non-isolated buck converter designed for use in a wide variety of applications. Packaged in an industry standard recognized SMT footprint: 1.3" x 0.53", it works from a wide input voltage range of 3V to 5.5V and offers a wide adjustable output range of 0.75V to 3.3V through external resistor programming.



Special Features

- Industry Standard SMT Footprint
- High Efficiency up to 95% at 3.3V output
- Adjustable output through external resistor programming
- Low output ripple and noise
- Input UVLO
- Fixed Switching Frequency
- Positive Enable
- Remote Sense pin

Environmental Specifications

- -40°C to 85°C Operating Temperature
- -40°C to 125°C Storage Temperature
- MTBF > 1 million hours

Electrical Parameters

Input

Input Range	3V to 5.5VDC
Input Surge	6V / 100ms

Control

Enable	TTL compatible (Positive or Negative Logic Enable Options)
--------	---

Output

Load Current	Up to 18A max (Po ≤ 60W)
Line/Load Regulation	< 0.5% V _O
Ripple and Noise	50mV _{P-P} max
Output Voltage	
Adjust Range	0.75 – 3.3V _O
Transient Response	300mV deviation (typical) 50% load change 25μs settling time (typical)
Remote Sense	+10% V _O
Over Current	150% I _O
Protection	
Over Temperature	120 °C max
Protection	

Safety

UL + cUL 60950, Recognized
EN60950 through TUV-PS



Technical Reference Notes APC18T04 Series



Electrical Specifications

ABSOLUTE MAXIMUM RATINGS

Stresses in excess of the absolute maximum ratings can cause permanent damage to the converter. Functional operation of the device is converter is not implied at these or any other conditions in excess of those given in the operational section of the specs. Exposure to absolute maximum ratings for extended period can adversely affect device reliability.

Parameter	Device	Symbol	Min	Typ	Max	Unit
Input Voltage Continuous Transient (100ms)	All	V_{IN} $V_{IN,trans}$	- -	- -	6 -	Vdc
Isolation Voltage Input to Output	All		NA	-	-	
Operating Temperature	All	T_a	-40	-	85	°C
Storage Temperature	All	T_{STG}	-40	-	125	°C
Operating Humidity	All	-	10	-	85	%
Max Voltage at Enable Pin	All		-	-	15	Vdc
Max Output Power			-	-	60	W

INPUT SPECIFICATION

Parameter	Device	Symbol	Min	Typ	Max	Unit
Operating Input Voltage Range	All	V_{IN}	3.0	3.3 / 5.0	5.5	Vdc
Input Under-Voltage Lock-out T_ON Threshold T_OFF Threshold	All		2.7 2.4	2.9 2.6	3.0 2.7	Vdc
Input Current ¹ ($V_{IN} = V_{IN,Min}$; $I_O = I_{O,Max}$)	All	I_{IN-MAX}	-		18	A
Max P_{diss} @ $I_O = 0A$ ($V_{IN} = V_{IN,Nom}$)	3.3V _O 0.75V _O		- -	- -	0.8 0.5	W
Input Ripple Current ² 5Hz to 20MHz	All	I_{r1}	-	100	150	mAp-p
Inrush Transient	All	I^2t			0.1	A ² s



Technical Reference Notes APC18T04 Series



Electrical Specifications (continued)

OUTPUT SPECIFICATIONS

Parameter	Device	Symbol	Min	Typ	Max	Unit
Output Voltage Set point $V_{IN} = V_{IN, MIN}$ to $V_{IN, MAX}$; $I_O = I_{O, MAX}$		$V_{O, SET}$	0.74	0.75	0.76	Vdc
Output Regulation Line: $V_{IN} = V_{IN, min}$ to $V_{IN, max}$ Load: $I_O = I_{O, min}$ to $I_{O, max}$ Temp: $T_A = -40^\circ\text{C}$ to $+85^\circ\text{C}$	All	-	-	-	0.5	%
	All	-	-	15	30	mV
	All	-	-	-	0.5	%
Ripple and Noise ³ Peak-to-Peak: (5Hz to 20MHz)	All	-	-	25	50	mVp-p
Output Current ⁴	All	I_O	0	-	18	A
External Load Capacitance Cap ESR $\geq 1\text{ m}\Omega$ Cap ESR $\geq 10\text{ m}\Omega$	All				1000 5000	μF μF
Output Current-limit Inception ⁵	All	I_O		150	250	% I_O
Over Temperature Range ⁵ (AVG. PCB TEMP, measured at R11 location)	All		100	110	120	$^\circ\text{C}$
Efficiency $V_{IN} = 5V_{IN-NOM}$, $I_O = I_{O, MAX}$; $T_A = 25^\circ\text{C}$, 200LFM	0.75V	η	80	82	-	%
	1.20V	η	85	87	-	%
	1.50V	η	87	89	-	%
	1.80V	η	88	90	-	%
	2.50V	η	91	92.5	-	%
	3.30V	η	93	95	-	%
Output voltage rise time $V_{IN} = V_{IN-MIN}$ to V_{IN-MAX}	All	-	-	3	6	ms
Enable to Output Turn-ON Delay $V_{IN} = V_{IN-MIN}$ to V_{IN-MAX} $I_O = I_{O, MIN}$ to $I_{O, MAX}$	All	-	-	-	14	ms
Switching Frequency	All	-	250	300	350	kHz
Output Turn-on Overshoot Output Turn-off undershoot (Passive Resistive Full Load)	All	-	-	-	2 -0.5	% V_O V
Output Enable ON/OFF Positive Enable Enable Pin Voltage: Mod-ON Mod-OFF	All	- -	2.4 0	- -	15 0.8	V V



Technical Reference Notes
APC18T04 Series



Electrical Specifications *(continued)*

OUTPUT SPECIFICATIONS

Parameter	Device	Symbol	Min	Typ	Max	Unit
Dynamic Response ($C_O = 10\mu\text{F}$ Tantalum + $1\mu\text{F}$ Ceramic) Load Change of 50% step anywhere between 10% to 100% of rated load	$\Delta I_O/\Delta t$	-	-	2.5	-	A/ μs
Peak Deviation	All	-	-	300	350	mV
Settling Time to $V_{O, \text{Nom}} < 5\%$		-	-	25	50	μs
Peak deviation						
Dynamic Response ($C_O = 150\mu\text{F}$ x2 Special Polymer Aluminum Capacitors) Load Change of 50% step anywhere between 10% to 100% of rated load	$\Delta I_O/\Delta t$			2.5		A/ μs
Peak Deviation	All			150	200	mV
Settling Time to $V_{O, \text{Nom}} < 5\%$				150	200	μs
Peak deviation						
Output Voltage Trim Range ⁶	All		0.75		3.63	V
Remote Sense	All			-	10%	V

- NOTE:
1. The converter is not internally fused.
 2. External input capacitance required. See Figure 1.
 3. Refer to Appendix A3 for the output ripple and Noise Test Measurement Setup.
 4. Output current limited by $60\text{W}/V_o$. Output Power Derating applies at elevated temperature. See Thermal Derating Curves.
 5. OCP and OTP are in hiccup mode. The converter will auto restart once the fault is removed.
 6. The voltage difference between input and output must be greater than 0.7V.

Electrical Specifications *(continued)*

SAFETY AGENCY / MATERIAL RATING / ISOLATION

Parameter	Device	
Safety Approval	All	UL/cUL 60950, Flammability and Temperature Rise, TUV EN 60950
Material Flammability Rating	All	UL94V-0
Input to Output Insulation Type	All	Non-Isolated

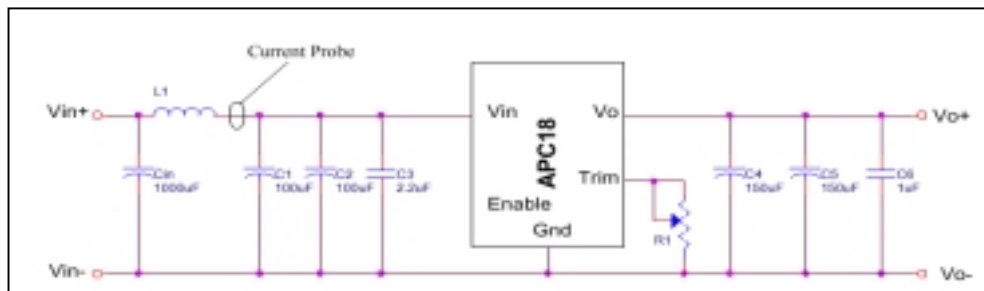

Figure 1. Input Reflected-ripple Test Set-up

Measure input reflected current with a simulated source inductance L1 of 1uH.
Capacitor Cin offsets possible battery impedance. Measure current as shown above.

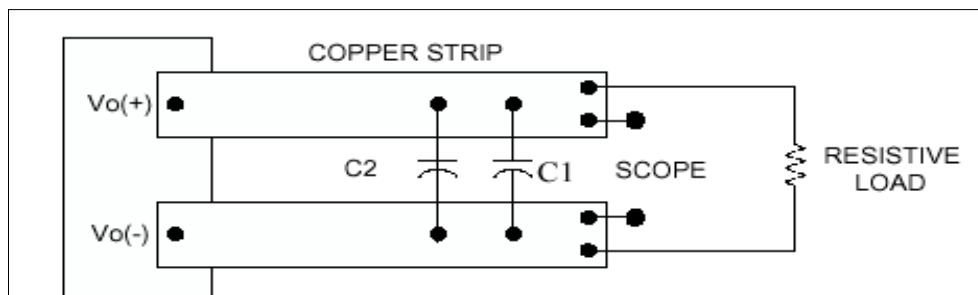
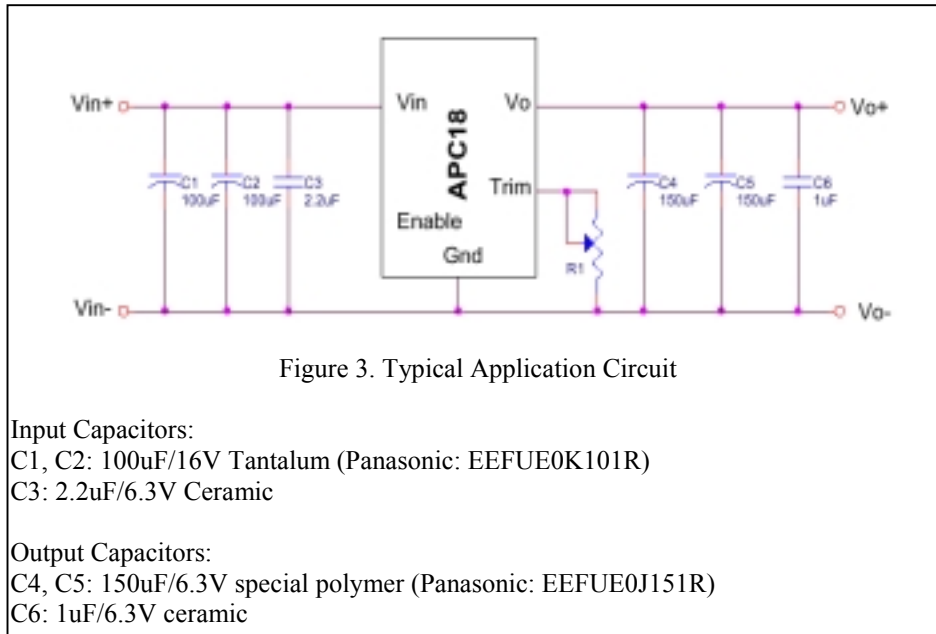

Figure 2. Peak-to-Peak Output Noise Measurement Test Set-up

Note:

- (1) Use C1 = 1uF@50V X7R ceramic capacitor and a 10uF@10V tantalum capacitor.
- (2) Use C2 = 2 x 150uF/6.3V special polymer (Panasonic: EEFUE0J151R)
- (3) Scope measurement should be made using a BNC socket.

Typical Application Circuit



Enable Pin

The converter comes with an Enable pin primarily used to turn ON/OFF the converter. The converter is disabled (OFF) when the voltage across the Enable pin and ground is between 0V to 0.8V. The converter is Enabled (ON) when the voltage across the Enable pin and ground is between 2.4V to 15V (or the Enable Pin is left open).

Output Trim

Output voltage adjustment is accomplished by connecting an external resistor between the Trim Pin and Ground Pin terminals. Resistance and Output voltage relationship is established by Equation 1. If Trim pin is left open – default $V_o = 0.75V$

TRIM-UP EQUATION:

$$R_{trim} = \left(\frac{21070}{V_o - 0.7525} - 5110 \right) \Omega \quad (1)$$

Where R_{trim} is the resistance value in ohms and V_o in Volts is the output voltage desired.

Table Rtrim values for different output voltage adjustment

V_o (V)	0.75	1.2	1.5	1.8	2.1	2.5	3.3
Rtrim (KΩ) from Equation (1)	open	41.97K	23.08K	15K	10.53K	6.95K	3.16K
Rtrim (KΩ) from E96	open	42.2K	23.2K	15K	10.50K	6.98K	3.16K

Performance Curves

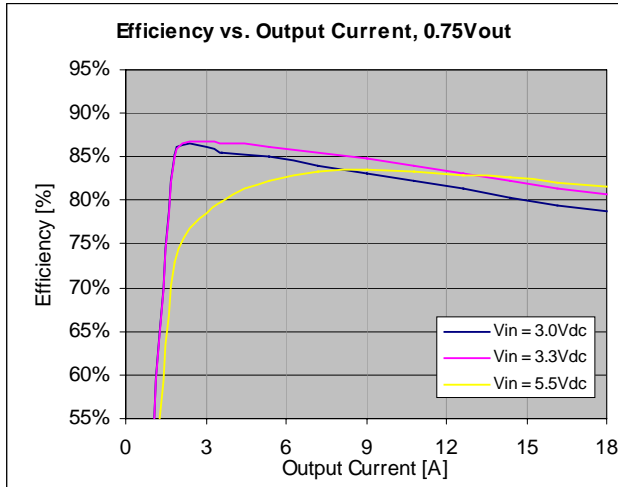

Figure 4. Efficiency vs. Load Current at ambient temperature, $T_A = 25^\circ\text{C}$.

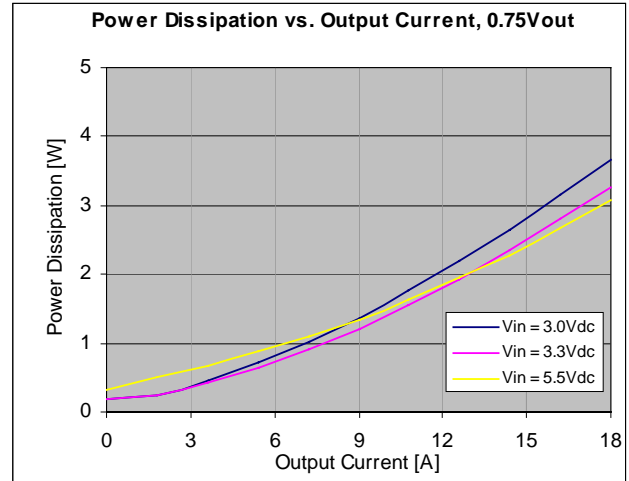

Figure 5. Power Dissipation vs. Load Current at ambient temperature, $T_A = 25^\circ\text{C}$.

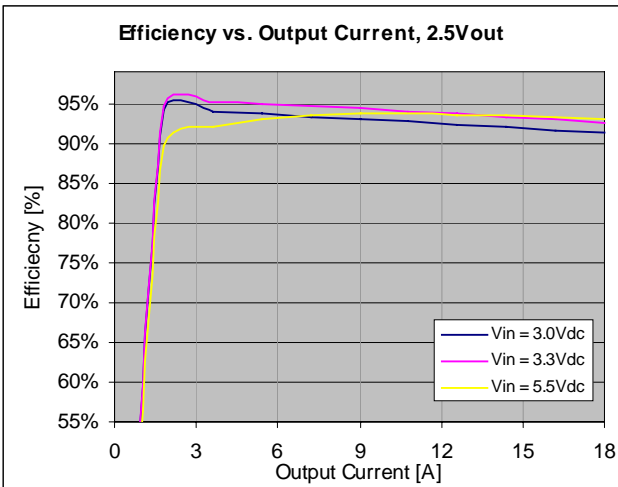

Figure 6. Efficiency vs. Load Current at ambient temperature, $T_A = 25^\circ\text{C}$.

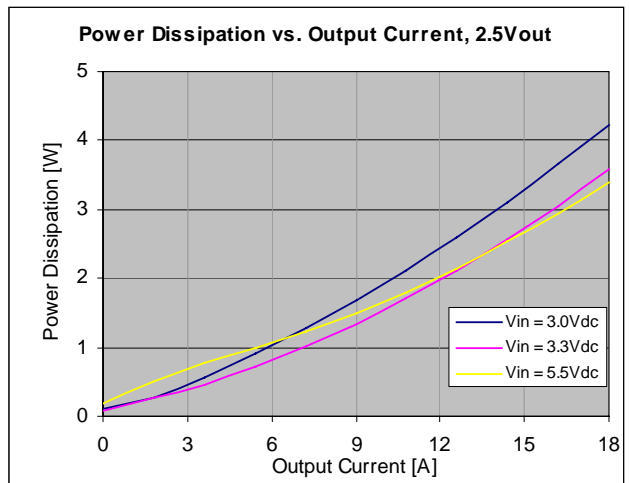

Figure 7. Power Dissipation vs. Load Current at ambient temperature, $T_A = 25^\circ\text{C}$.

Performance Curves (continued)

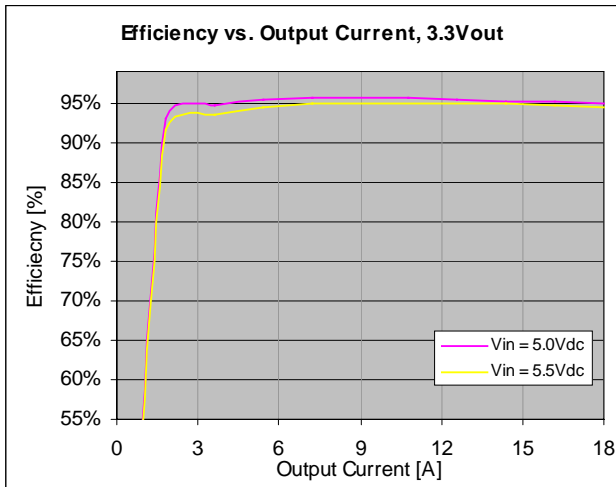

Figure 8. Efficiency vs. Load Current at ambient temperature, $T_A = 25^\circ\text{C}$.

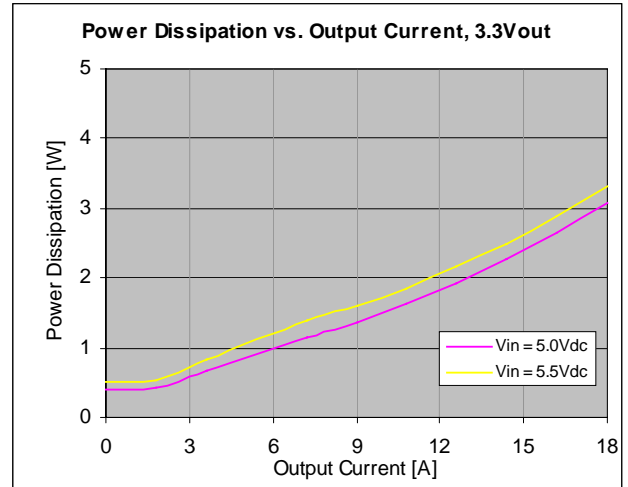

Figure 9. Power Dissipation vs. Load Current at ambient temperature, $T_A = 25^\circ\text{C}$

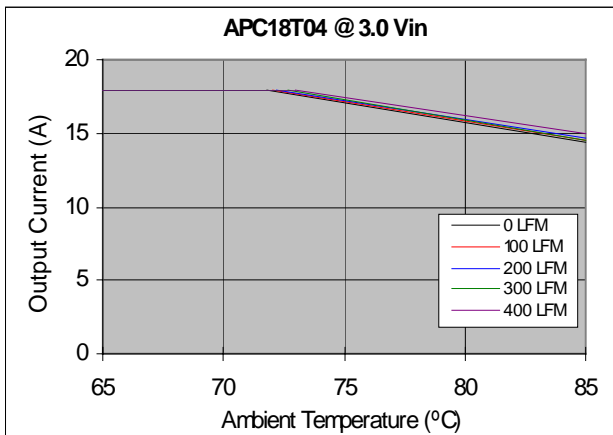

Figure 10. Output Power Derating Curve for $0.75V_{OUT}$ at $V_{IN} = 3V$, $T_A = 25^\circ\text{C}$

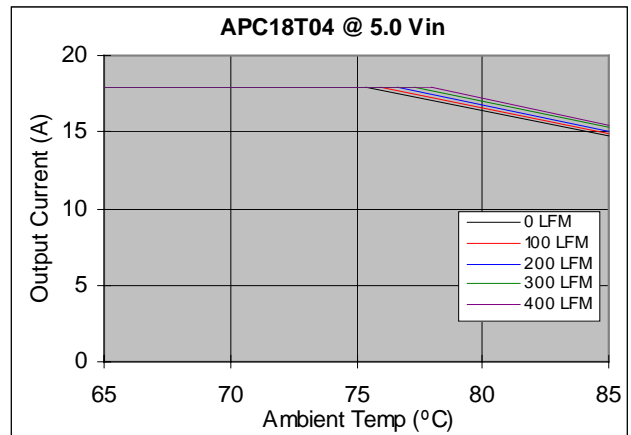

Figure 11. Output Power Derating Curve for $0.75V_{OUT}$ at $V_{IN} = 5V$, $T_A = 25^\circ\text{C}$

Performance Curves (continued)

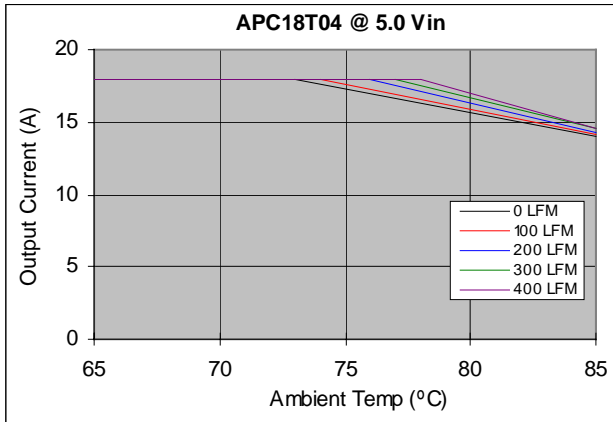

Figure 12. Output Power Derating Curve for 1.5V_{OUT} at V_{IN} = 5V, T_A = 25°C

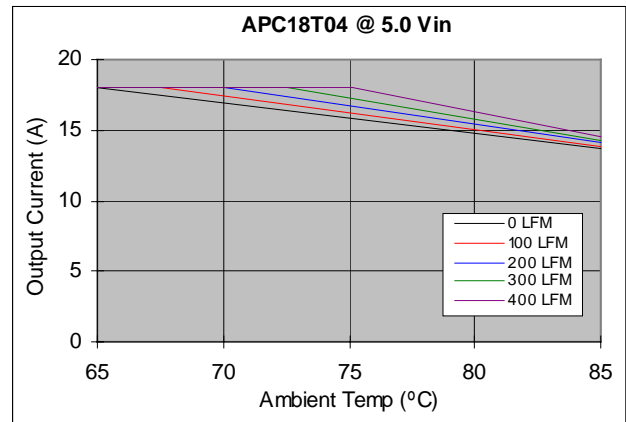

Figure 13. Output Power Derating Curve for 1.8V_{OUT} at V_{IN} = 5V, T_A = 25°C

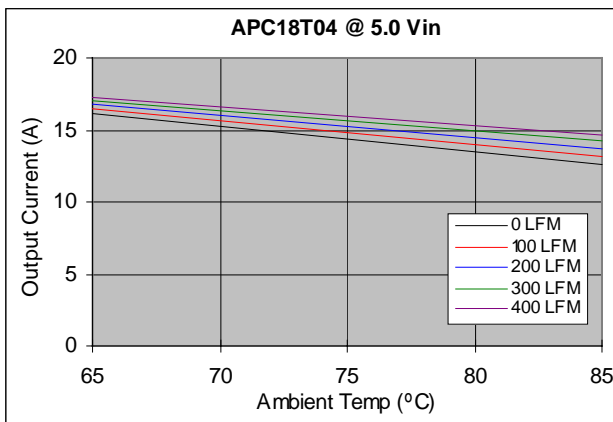

Figure 14. Output Power Derating Curve for 2.5V_{OUT} at V_{IN} = 5V, T_A = 25°C

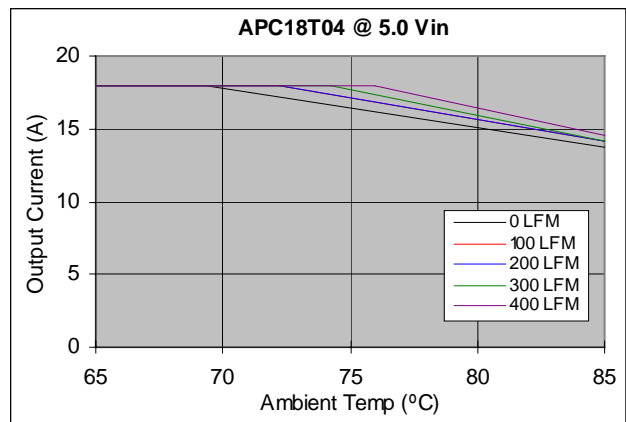

Figure 15. Output Power Derating Curve for 3.3V_{OUT} at V_{IN} = 5V, T_A = 25°C

Performance Curves (continued)

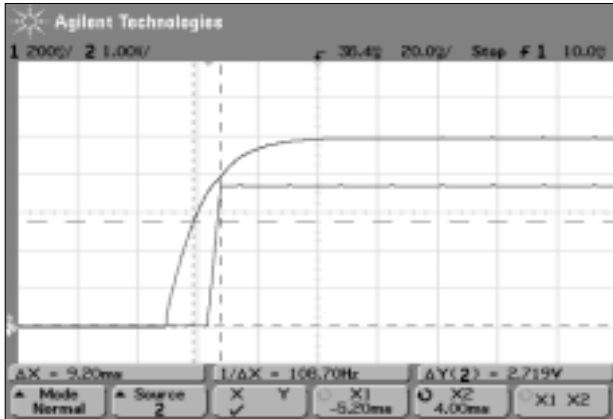

Figure 16. Output Startup Waveform for 0.75V_{OUT} at V_{IN} = 5V, I_{OUT} = 18A.

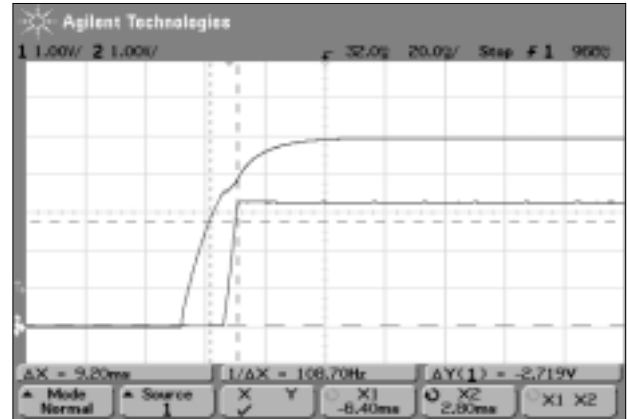

Figure 17. Output Startup Waveform for 3.3V_{OUT} at V_{IN} = 5V, I_{OUT} = 18A.

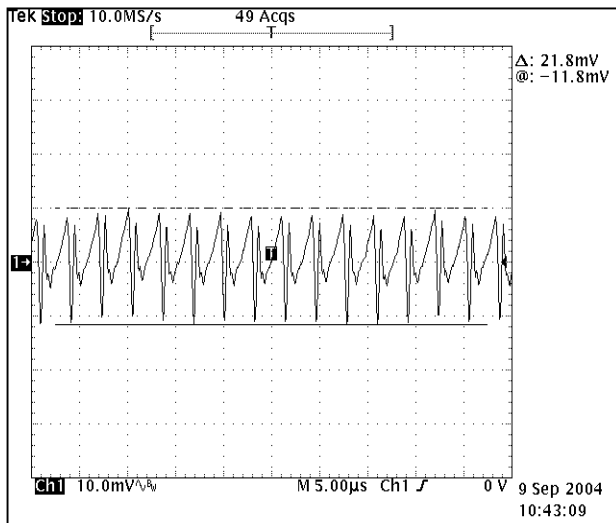

Figure 18. 2V5 Output Ripple Waveform at Vin = 3V, Iout = 18A, T_A = 25°C.

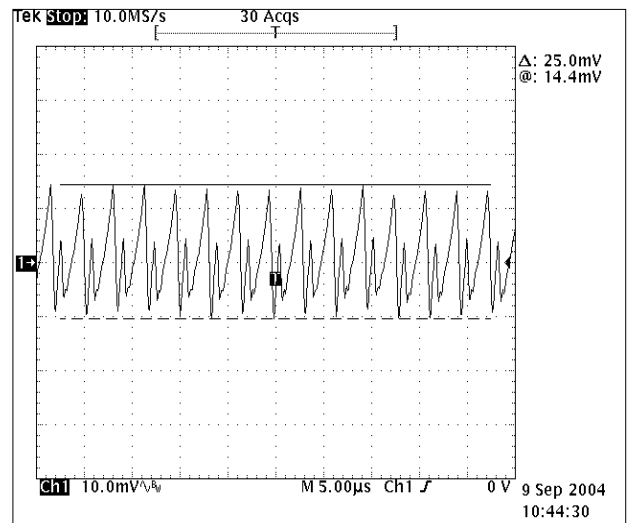

Figure 19. 2V5 Output Ripple Waveform at Vin = 3.3V, Iout = 18A, T_A = 25°C.

Performance Curves (continued)

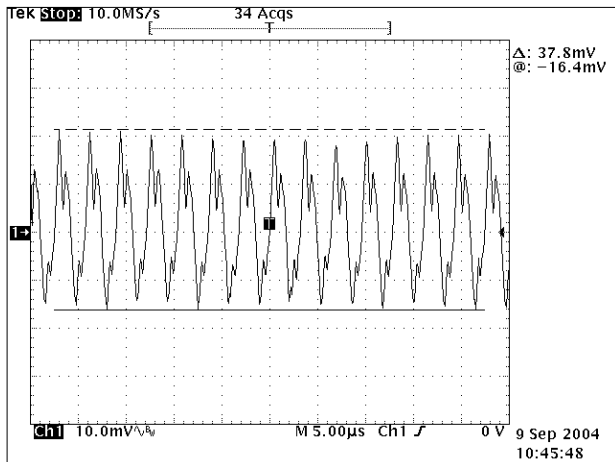

Figure 20. 2V5 Output Ripple Waveform at $V_{in} = 5.5V$, $I_{out} = 18A$, $T_A = 25^\circ C$.

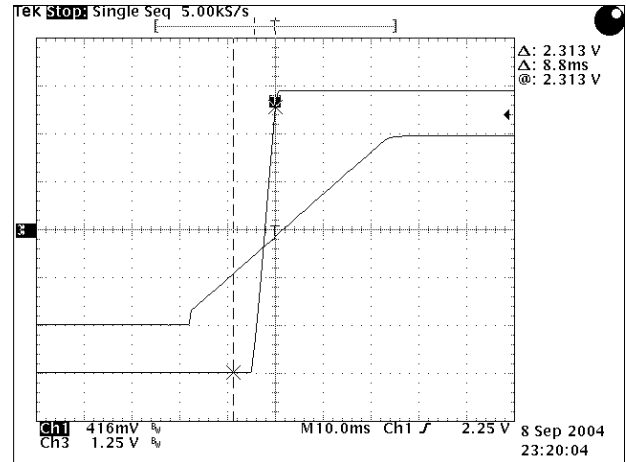

Figure 21. 2V5 Output Enable Turn On Characteristic at $V_{in} = 3.3V$, $T_A = 25^\circ C$.

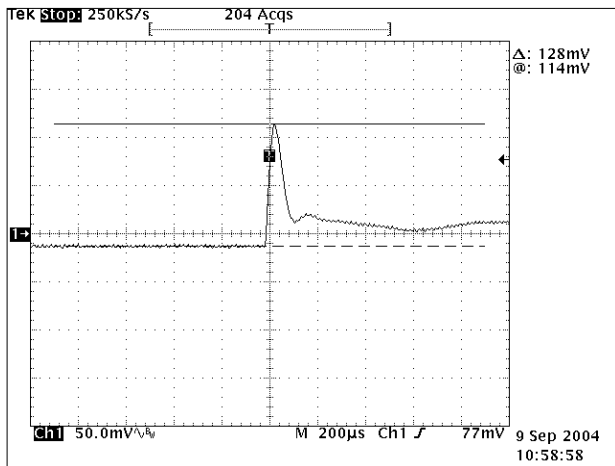

Figure 22. 2V5 Output Transient Response (100% to 50% I_{omax}) at $V_{in} = 3.3V$, $T_A = 25^\circ C$.

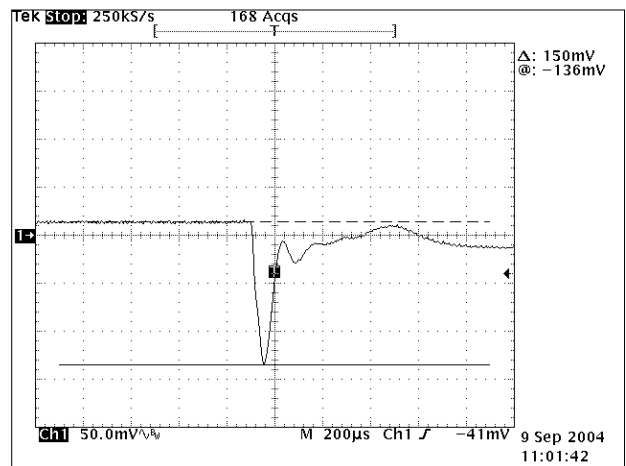
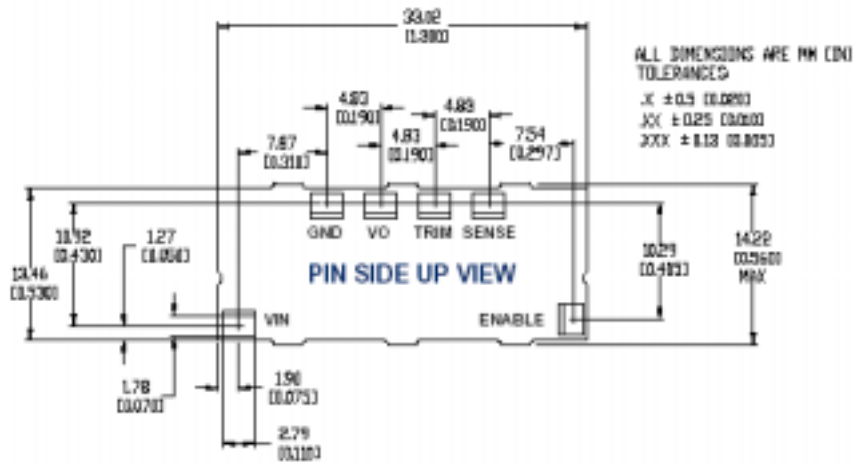

Figure 23. 2V5 Output Transient Response (50% to 100% I_{omax}) at $V_{in} = 3.3V$, $T_A = 25^\circ C$.

Mechanical Specifications

Parameter	Device	Symbol	Min	Typ	Max	Unit
Dimension	All	L	-	-	1.3 [33.02]	in [mm]
		W	-	-	0.53 [13.46]	in [mm]
		H	-	-	0.33 [8.33]	in [mm]
Weight	All		-	5.8 [0.21]	-	g [oz]
PIN DESIGNATION						
V _{IN}	+Input Voltage Return for V _{IN} and V _O	SENSE TRIM ENABLE	+Output Sense Pin V _O Adjust ON/OFF			
GND						
V _O						



Recommended PAD Layout

PAD Size
 MIN: 1.6 x 2.8 mm [0.065 x 0.110 inches]
 REC: 1.8 x 2.8 mm [0.070 x 0.110 inches]
 MAX: 2.0 x 3.0 mm [0.080 x 0.130 inches]

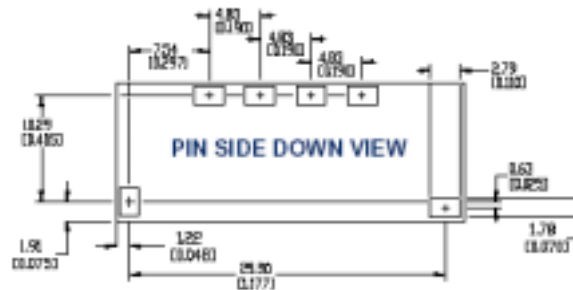

Figure 24. Mechanical Outline

RECOMMENDED LOCATION FOR PICK AND PLACE

The flat top surface of the large inductor (topside of the board) provides a versatile and convenient way of picking up the module (See Figure 25). A 6-7mm outside diameter nozzle from a conventional SMD machine is recommended to attain maximum vacuum pick-up. Nozzle travel and rotation speed should be controlled to prevent this off-centered picked-up module from falling off the nozzle. The use of vision recognition systems for placement accuracy will be very helpful.

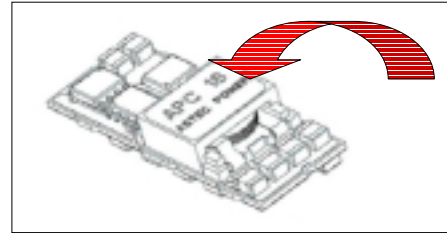

Figure 25. Pick-up location

REFLOW NOTES / RECOMMENDATIONS

1. Refer to the recommended Reflow Profile per Figure 26. Profile parameters exceeding the recommended maximums may result to permanent damage to the module.
2. The module is recommended for topside reflow process to the host card. For other orientations, contact factory.
3. In the event that the module needs to be desoldered from the host card, some pins may be detached from the module.

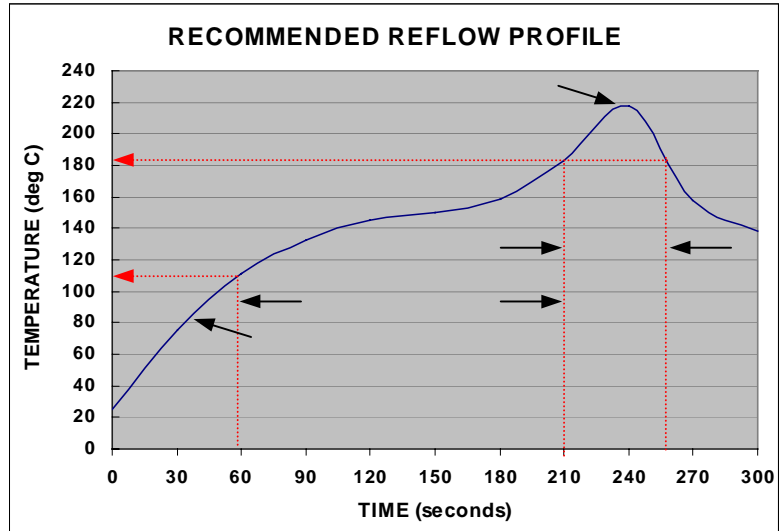

Figure 26. Recommended Reflow profile.

PART NUMBERING SCHEME

APC	O/P CURRENT	O/P VOLTAGE	I/P Voltage	-	9	OPTIONS
	18	T	04			(J)
	18 = 18A	T = 0.75 – 3.3V	04 = 3.0 – 5.5V		9 = output adjust	J = Tray packaging Non "J" = T&R packaging

Please call 1-888-41-ASTEC for further inquiries or visit us at www.astecpower.com