

POWER

CSV550BP

550 Watts Distributed Power System

Data Sheet

Front-end Bulk Power
Total Output Power: 550W
Input Voltage: 90 to 264 Vac

SPECIAL FEATURES

- 550 W output power
- 1U power supply
- Active Power Factor Correction
- EN61000-3-2 Harmonic compliance
- Inrush current control
- 80PLUS® Platinum efficiency
- N+N Redundant
- Hot-pluggable
- Active current sharing
- PMBus® compliant
- Two-year warranty

COMPLIANCE

- Conducted/Radiated EMI Class A Limits
- RoHS
- IEC 60950

SAFETY

- UL/cUL
- CB Test Certificate
- CE Mark
- KC
- CCC/CQC
- BSMI



Electrical Specifications

Input						
Input range	90 - 264 Vac: 550 W					
Frequency	47 Hz to 63 Hz					
Efficiency	Platinum level					
Max input current	6.5 A @ 100 Vac					
Inrush current	30 Apk					
Conducted EMI	Class A					
Radiated EMI	Class A					
Power factor	>0.9 beginning at 20% load					
Hold-up time	12 ms at full load					
Leakage current	0.8 mA					
Output						
	Main DC Output			Standby DC Output		
	MIN	NOM	MAX	MIN	NOM	MAX
Nominal setting	-0.20%	12.2	0.20%	-3.5%	12.0	+3.5%
Total output regulation range	11.59V		12.81 V	11.4 V		12.6 V
Dynamic load regulation range	11.59 V		12.81 V	11.4 V		12.6 V
Output ripple			120 mVp-p			120 mVp-p
Output current	1.0 A ¹		45.1A	0.0 A		2.5 A
Current sharing	Within ±10% of full load rating, starting at 30% of rated load			N/A		
Capacitive loading	1,000 µF		20,000 µF	50 µF		500 µF
Start-up from AC to output			3,000 ms			2,500 ms
Output rise time	2 ms		20 ms	2 ms		20 ms

¹ Minimum current for transient load response testing only. Unit is designed to operate without damage at zero load.

Electrical Specifications

Protections			
Main Output	MIN	NOM	MAX
Overcurrent protection ²	45.1 A		56.4 A
Oversvoltage protection ¹	13.8 V		
Undersvoltage protection			10.0 V
Overtemperature protection		Yes	
Fan fault protection		Yes	
Standby Output			
Overcurrent protection ³	3.9 A		
Oversvoltage protection ³	13.8 V		
Undersvoltage protection			10.0 V

¹ Latch mode

² THROTTLE warning before shutdown. Latch mode.

³ Standby protection is auto-recovery

LED Indicators

	Input Good (Green)	Output Good (Green)	Fault (Yellow)
Output ON and OK	On	On	Off
Standby mode (input present, main output off) or zero output mode	On	Blinking 1 Hz	Off
No input/Input out of range	Off	Off	Off
OCP, or over-subscription fault, or OVP, or fan failure, or OTP	On	Off	On

Environmental Specifications

Operating temperature	5 to 50 °C
Operating altitude	up to 10,000 feet ¹
Operating relative humidity	+8% to 93%, non-condensing
Non-operating temperature	-40 to +60 °C
Shipping and storage relative humidity	+5% to 100%, including condensing
Non-operating altitude	up to 50,000 feet
Vibration and shock	Standard operating/non-operating random shock and vibration
RoHS compliance	Yes
MTBF	500 k hours at 40 °C, 70% load, nominal input
Operating life	Minimum of 5 years at typical conditions

Notes: ¹ PSU ambient temperature derated at 1°C per 600 ft above 3000 ft

Ordering Information

Model Name	Ordering Part Number	Nominal Main Output	Standby Output	Airflow Direction
CSV550BP-3	700-013702-2000	12.2 V @ 45.1 A	12 V @ 2.5 A	Standard (forward)

Timing Diagram

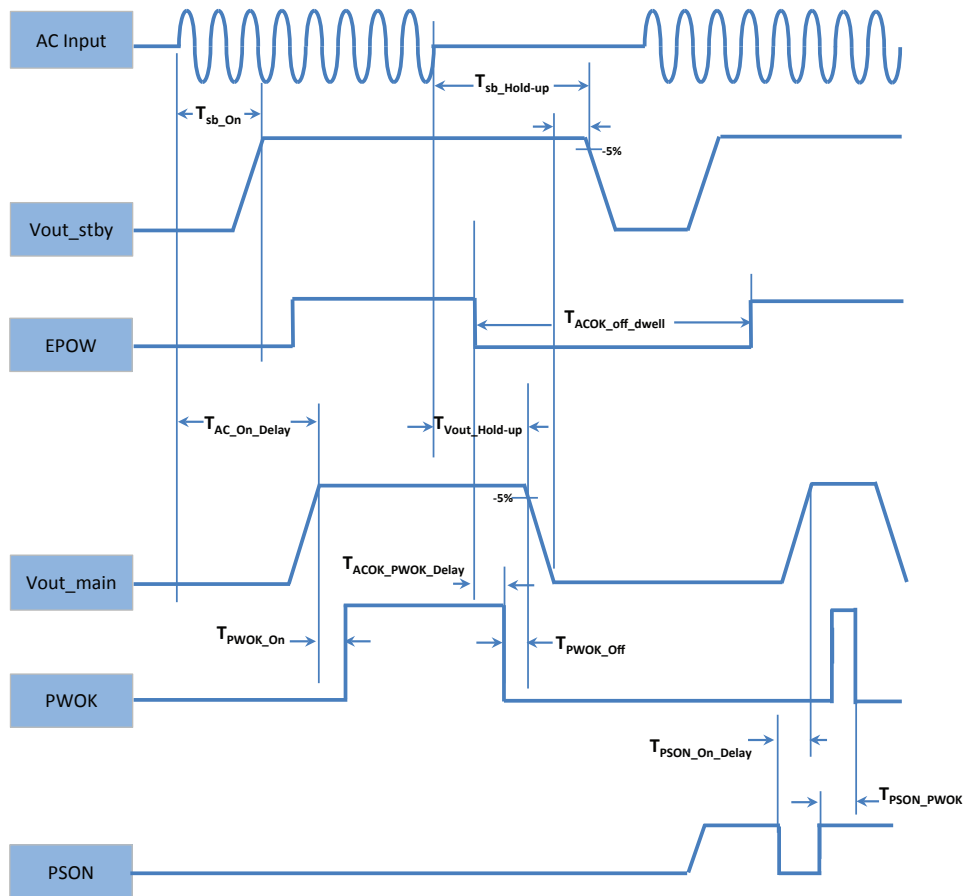

Timing Specifications				
	Description	Min	Max	Unit
T_{sb_On}	Delay from AC being applied to standby output being within regulation		2500	ms
T_{Vout_rise}	Rise time of output voltage going from 10% to 90% of the nominal regulation	1	50	ms
$T_{AC_On_Delay}$	Delay from AC being applied to main output being within regulation		3000	ms
T_{PWOK_On}	Delay from output voltages within regulation limits to PWOK assertion	180	220	ms
$T_{ACOK_PWOK_Delay}$	Delay from ACOK going low to deassertion of PWOK	6		ms
$T_{Vout_Hold-up}$	Delay from loss of AC to main output being within regulation	12		ms
$T_{sb_Hold-up}$	Delay from loss of AC to standby output being within regulation	50	1000	ms
T_{PWOK_Off}	Delay from deassertion of PWOK to output falling out of regulation	2		ms
T_{PSON_PWOK}	Delay from deassertion of PSON to deassertion of PWOK		1	
$T_{PSON_On_Delay}$	Delay from PSON assertion to output being within regulation		100	ms

Mechanical Outline

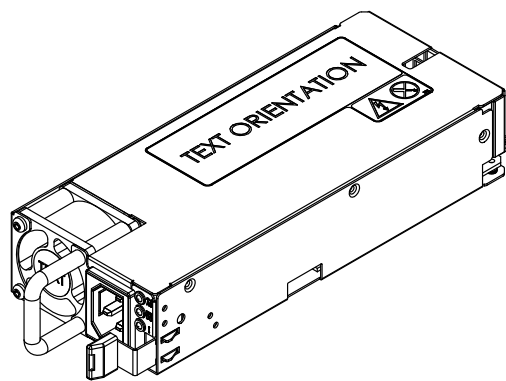
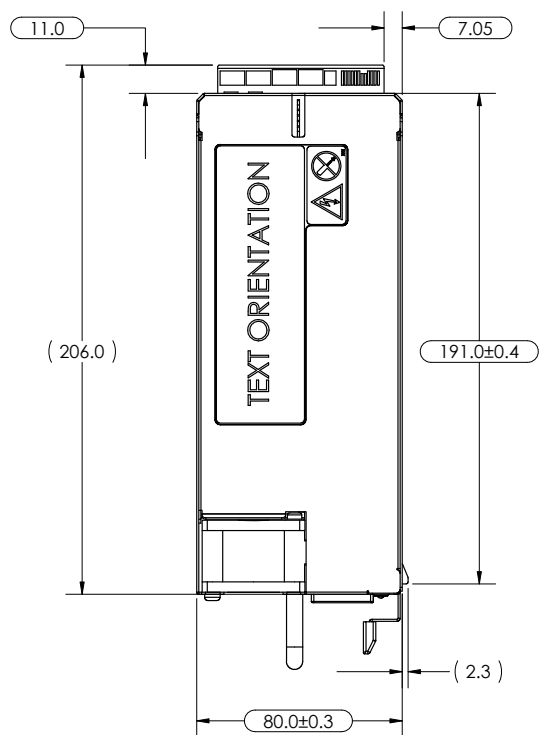

IT IS ACCEPTABLE FOR THE AC CONNECTOR HOUSING TO TOUCH THE LED HOUSINGS

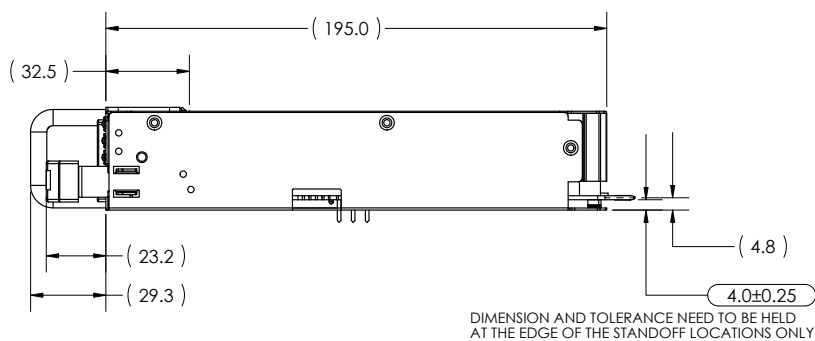
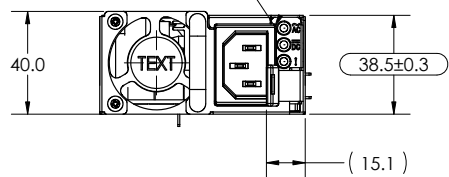

ALL DIMENSIONS ARE IN MM. TOLERANCE IS +/-0.5MM

Connector Definitions

Output connector part number	Card-edge
Mating connector part number	FCI Amphenol HPCE 10122238-320424FLF

Power Supply Output Card Edge (Top Side)

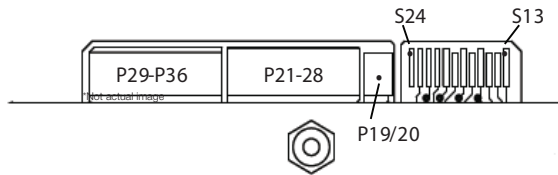

Power Supply Output Card Edge (Bottom Side)

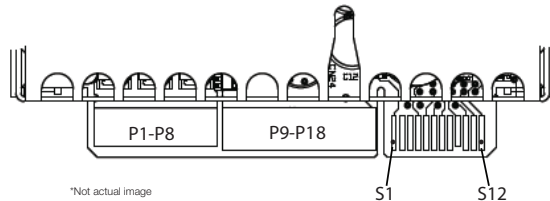

Output Connector Pin Configuration

S1	Reserved	S13	SMBUS_RESET
S2	Reserved	S14	Reserved
S3	+Vsense	S15	ADDRESS
S4	PSKILL	S16	PSON
S5	Reserved	S17	PSON
S6	PWOK	S18	ACOK
S7	PRESENT	S19	Reserved
S8	SMB_ALERT#	S20	THROTTLE
S9	ISHARE	S21	Reserved
S10	RETURN	S22	-Vsense
S11	SDA	S23	Reserved
S12	SCL	S24	Reserved
P1-P8	Vo	P29-P36	Vo
P9-P18	RTN	P21-P28	RTN
		P19-P20	VSB

Power Supply Addressing (pin S15)

Resistance (pull-down at system side, 1% tol or better)	Voltage (nom)	Hex Address
OPEN	12.00 V	D0
280 k	10.49 V	D2
212 k	9.01 V	D4
68.1 k	7.55 V	D6
40.2 k	6.00 V	D8
23.7 k	4.45 V	DA
13.3 k	2.98 V	DC
5.76 k	1.50 V	DE

WORLDWIDE OFFICES

Americas

2900 S.Diablo Way
Tempe, AZ 85282
USA
+1 888 412 7832

Europe (UK)

Waterfront Business Park
Merry Hill, Dudley
West Midlands, DY5 1LX
United Kingdom
+44 (0) 1384 842 211

Asia (HK)

14/F, Lu Plaza
2 Wing Yip Street
Kwun Tong, Kowloon
Hong Kong
+852 2176 3333

ARTESYN
EMBEDDED TECHNOLOGIES

www.artesyn.com

Artesyn Embedded Technologies, Artesyn and the Artesyn Embedded Technologies logo are trademarks and service marks of Artesyn Embedded Technologies, Inc. All other names and logos referred to are trade names, trademarks, or registered trademarks of their respective owners. Specifications are subject to change without notice. © 2017 Artesyn Embedded Technologies, Inc. All rights reserved. For full legal terms and conditions, please visit www.artesyn.com/legal.

For more information: www.artesyn.com/power
For support: productsupport.ep@artesyn.com