

Description

The AGF600-24S28 is a single output DC-DC converter with standard full-brick outline and pin configuration. It delivers up to 21.5A output current with 28V output voltage. Above 94.0% ultra-high efficiency and excellent thermal performance make it an ideal choice to supply power to power amplifier in telecom RF application. Thanks to the aluminium baseplate it can work under -40°C ~ +85°C without air cooling.

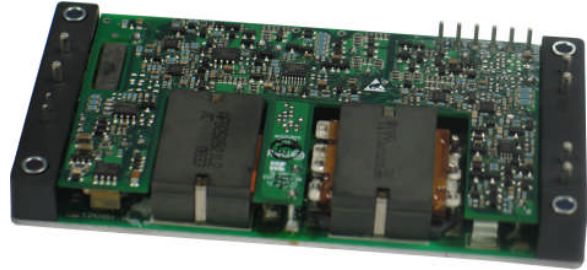

Operational Features

- Delivering up to 21.5A output current
- Ultra-high efficiency 94% typ. at half load
- Excellent thermal performance
- Wide input range: 18V ~ 36V
- No minimum load requirement
- Fixed frequency operation
- RoHS 6 compliant

Control Features

- Remote control function
- Remote output sense
- Trim function: -50% ~ +18%

Protection Features

- Input under voltage protection
- Output over current protection
- Output over voltage protection
- Over temperature protection

Mechanical Features

- Industry standard full-brick pin-out outline
- With aluminium baseplate
- Pin length: 3.8mm

Safety & EMC

- Meets safety standards UL 60950-1, IEC/EN 60950-1 and GB4943
- Approved by UL and TUV
- Meets 2006/95/EEC and 93/68/EEC directives which facilitates CE marking in user's end product
- Meets conducted emission's requirements of EN55022 Class A with external filter

Electrical Characteristics

Full operating ambient temperature range is -40°C to +85°C.

Specifications are subject to change without notice.

| Parameter | | Min. | Typ. | Max. | Unit | Notes & Conditions |
|--|----------------------------|-------|-------------|-------|------------------|---|
| Absolute max. ratings | | | | | | |
| Input voltage | Non-operating | | | 50 | V | 100ms |
| | Operating | | | 36 | V | Continuous |
| Operating temperature | | -40 | | 85 | °C | |
| Storage temperature | | -55 | | 125 | °C | |
| Input characteristics | | | | | | |
| Operating input voltage range | | 18 | 24 | 36 | V | |
| Input under-voltage lockout | Turn-on voltage threshold | 15 | | 18 | V | |
| | Turn-off voltage threshold | 14 | | 17 | V | |
| | Lockout voltage hysteresis | 1 | | 3 | V | |
| Max. input current | | | | 40 | A | 18V _{in} , full load |
| No-load input current | | | 0.5 | 0.7 | A | 24V _{in} |
| Standby Input current | | | 0.05 | 0.1 | A | Remote OFF |
| Inrush current transient rating | | | 0.5 | 1 | A ² s | Figure 18 |
| Input reflected ripple current | | | | 320 | mA | Through 12μH inductor; Figure 18 |
| Recommended input fuse | | | 60 | | A | Fast blow external fuse recommended Figure 13 |
| Input filter component values (C\L) | | | 4.7*13\0.35 | | μF\μH | Internal values |
| Recommended external input capacitance | | | 1000 | | μF | Low ESR capacitor recommended Figure 13 |
| Output characteristics | | | | | | |
| Output voltage set point (standard option) | | 27.72 | 28 | 28.28 | V | 24V _{in} , full load |
| Output voltage line regulation | | | 0.1 | 0.2 | % | |
| | | | 28 | 56 | mV | |
| Output voltage load regulation | | | 0.2 | 0.5 | % | |
| | | | 56 | 140 | mV | |

| Parameter | | Min. | Typ. | Max. | Unit | Notes & Conditions |
|---------------------------------------|--|-------|------|-------|---------|---|
| Output voltage temperature regulation | | | | 0.02 | %/°C | |
| Total output voltage range | | 27.20 | 28 | 28.80 | V | Over sample, line, load, temperature & life |
| Output voltage ripple and noise | | | | 200 | mVpp | 20MHz bandwidth; Figure 18 |
| Operating output current range | | 0 | | 21.5 | A | |
| Output DC current-limit inception | | 23.65 | | 30.1 | A | Hiccup, see Figure 12 |
| Output capacitance | | 470 | 1000 | 10000 | μF | |
| Dynamic characteristics | | | | | | |
| Dynamic response | 25% ~ 50% ~ 25% $I_{o,max}$, 0.1A/μs | | | 840 | mV | Figure 6 Test condition: see Figure 13 |
| | Settling time | | | 500 | μs | Recovery to within 1% $V_{o,nom}$ |
| | 50% ~ 75% ~ 50% $I_{o,max}$, 0.1A/μs | | | 840 | mV | Figure 7 Test condition: see Figure 13 |
| | Settling time | | | 500 | μs | Recovery to within 1% $V_{o,nom}$ |
| Turn-on transient | Rise time | 20 | | 200 | ms | Full load, Figure 8 |
| | Turn-on delay time | 0 | | 200 | ms | |
| | Output voltage overshoot | | | 5 | % V_o | |
| Efficiency | | | | | | |
| 100% load | | | 92.0 | | % | Figure 1 |
| 50% load | | | 94.0 | | % | Figure 1 |

Electrical Characteristics (Continued)

| Parameter | Min. | Typ. | Max. | Unit | Notes & Conditions |
|----------------------------------|------|------|------|------|---|
| Isolation characteristics | | | | | |
| Isolation voltage (1mA, 5s) | | 1500 | | V | Basic insulation, pollution degree 2, input to output |
| | | 1500 | | V | Basic insulation, pollution degree 2, input to baseplate |
| | | 500 | | V | Basic insulation, pollution degree 2, output to baseplate |

| Parameter | Min. | Typ. | Max. | Unit | Notes & Conditions |
|------------------------------------|------|------|------|----------|---|
| Feature characteristics | | | | | |
| Switching frequency | 200 | 230 | 260 | kHz | |
| Remote ON/OFF control | 1.5 | | 5 | mA | See Figure 14 and Figure 15 |
| Output voltage trim range | 14 | | 33 | V | See <i>Trim Characteristics of Application Note</i> |
| Output voltage remote sense range | | | 1 | V | |
| Output over-voltage protection | 125 | | 143 | % | Over full temp range; % of $V_{o,nom}$ Latch: reset by power on or remote on |
| Over-temperature shutdown | 105 | 115 | 130 | °C | Auto recovery; Test point: see Figure 21 |
| Over-temperature hysteresis | 5 | | | °C | |
| Reliability characteristics | | | | | |
| Calculated MTBF (telcordia) | | 1.5 | | 10^6 h | Telcordia SR-332-2006; 80% load, 300LFM, 40°C T_a |

Qualification Testing

| Parameter | Unit (pcs) | Test condition |
|------------------|------------|---|
| Halt test | 4 ~ 5 | $T_{a,min}$ -10°C to $T_{a,max}$ +10°C, 5°C step, V_{in} = min to max, 0 ~ 105% load |
| Vibration | 3 | Frequency range: 5Hz ~ 20Hz, 20Hz ~ 200Hz, A.S.D: $1.0m^2/s^3$, -3db/oct, axes of vibration: X/Y/Z; Time: 30min/axis |
| Mechanical shock | 3 | 30g, 6ms, 3axes, 6directions, 3time/direction |
| Thermal shock | 3 | -40°C to 100°C, unit temperature 20cycles |
| Thermal cycling | 3 | -40°C to 85°C, temperature change rate: 1°C/min, cycles: 2cycles |
| Humidity | 3 | 40°C, 95%RH, 48h |
| Solder ability | 15 | IPC J-STD-002C-2007 |

Characteristic Curves

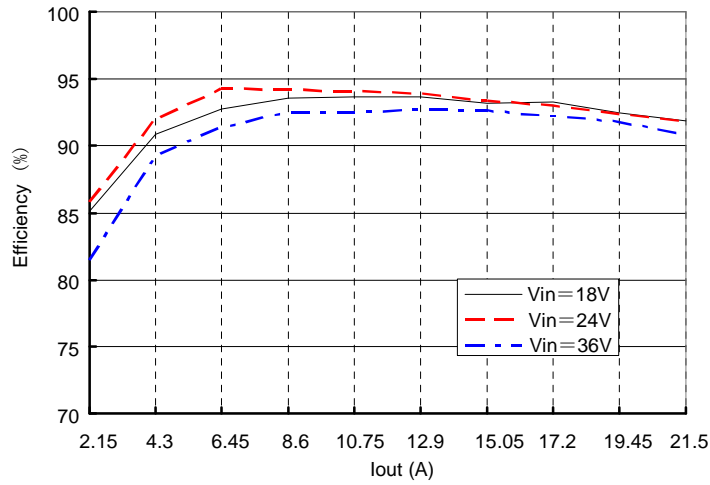

Figure 1 Efficiency vs. output current, T_a=25°C, V_o=28V

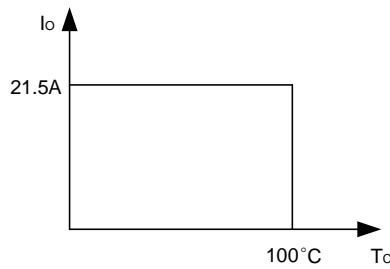

Figure 2 Output power derating curve

T_c: temperature test point on baseplate, see Figure 21 for test configuration.

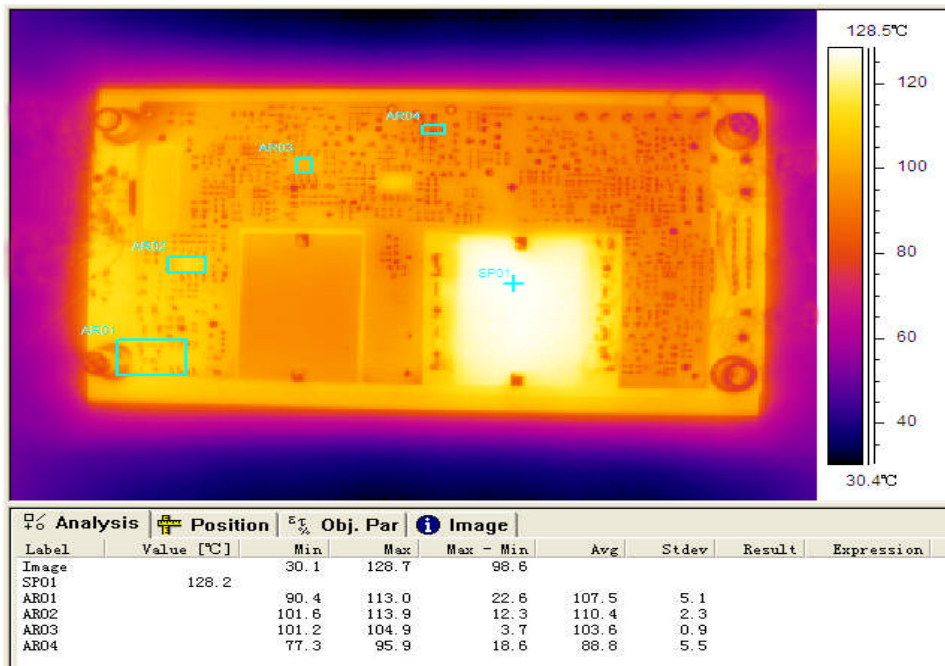

Figure 3 Thermal image, 24V_{in}, 28V_o, full load, room temperature

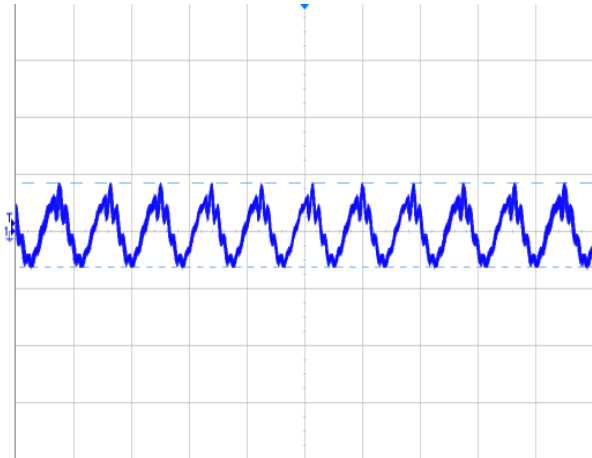

Figure 4 Output ripple & noise (5µs/div, 100mV/div), see Figure 18 for test configuration

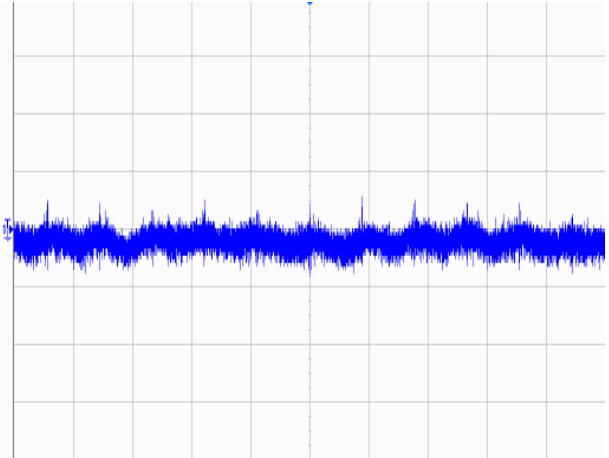

Figure 5 Input reflected ripple current (5µs/div, 20mA/div), see Figure 18 for test configuration

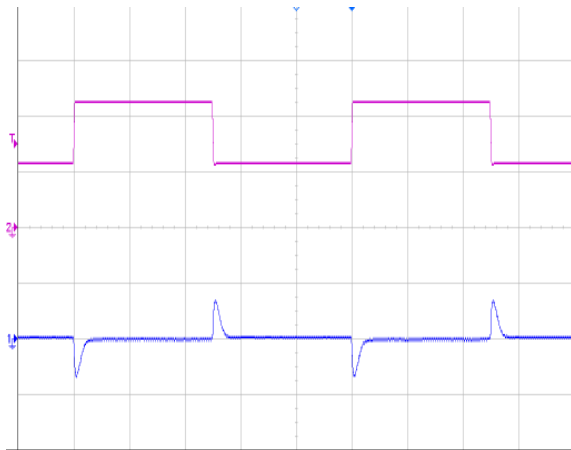

Figure 6 Dynamic response for 25% load step (25% ~ 50% ~ 75%) and 0.1A/µs slew rate, see Figure 13 for test configuration, CH1-output voltage (500mV/div); CH2-output current (5A/div)

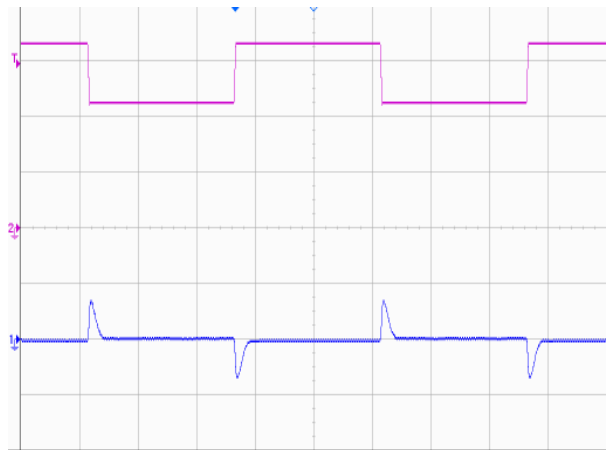

Figure 7 Dynamic response for 25% load step (50% ~ 75% ~ 50%) and 0.1A/µs slew rate, see Figure 13 for test configuration. CH1-output voltage (500mV/div); CH2-output current (5A/div)

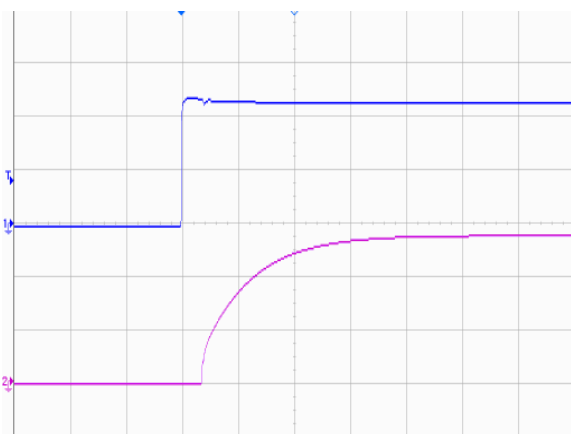

Figure 8 Output voltage startup by power on, (20ms/div), see Figure 13 for test configuration, CH1-input voltage (10V/div); CH2-output voltage (10V/div)

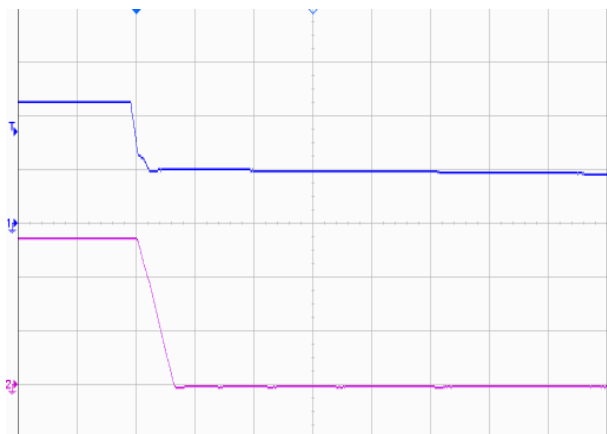

Figure 9 Output voltage shut down by power off, (2ms/div), see Figure 13 for test configuration, CH1-input voltage (10V/div); CH2-output voltage (10V/div)

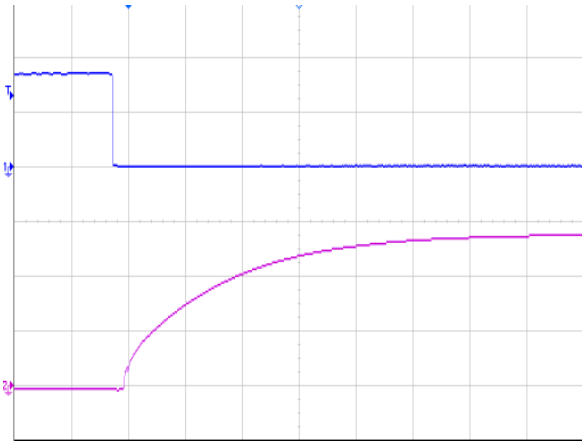

Figure10 Output voltage startup by remote ON, (10ms/div), see Figure 14 for test configuration, CH1-remote ON (2V/div); CH2-output voltage (10V/div)

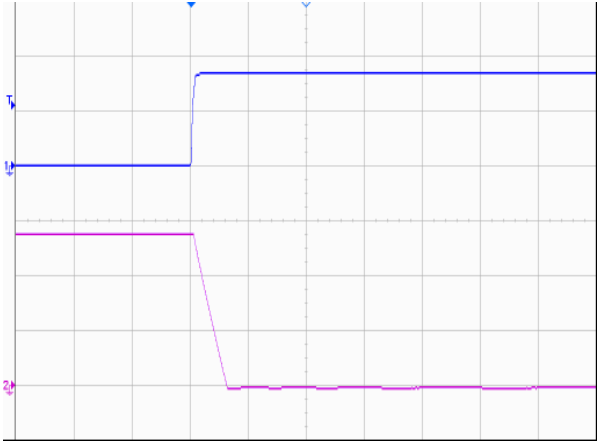

Figure 11 Output voltage shutdown by remote OFF, (2ms/div), see Figure 14 for test configuration, CH1-remote OFF (2V/div); CH2-output voltage (10V/div)

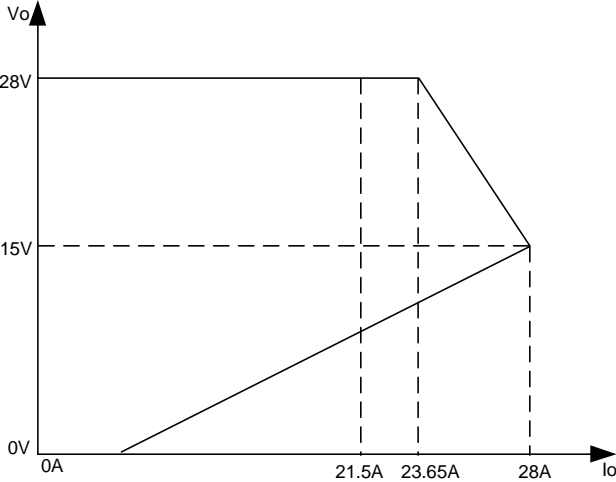

Figure 12 Over-current protection characteristics

(It's only a sketch map of OCP action. Little alteration of the current value vs. voltage value would be allowed.)

Application Note

Typical Application

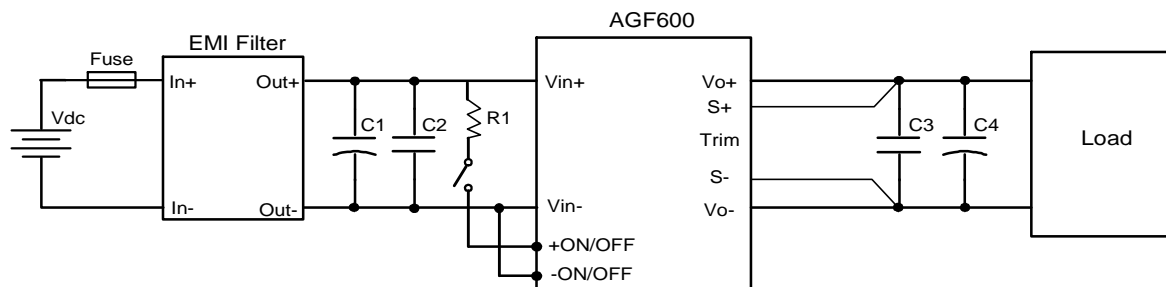

Figure 13 Typical application

R1: 10k Ω (1W) current limiting resistor

C1: 1000 μ F/50V electrolytic capacitor, P/N: UPW2A471MHD (Nichicon) or equivalent caps

C2, C3: 1 μ F/100V X7R ceramic capacitor, P/N: C3225X7R2A105KT0L0U(TDK) or equivalent caps

C4: 7X150 μ F electrolytic capacitor, P/N: UUD1H151MNL1GS (Nichicon) or equivalent caps

Note: If ambient temperature is below -5 $^{\circ}$ C, additional 1000 μ F electrolytic capacitor is needed for output.

Fuse: External fast blow fuse with a rating of 60A. The recommended fuse model is F60AH (100/250V).

Remote ON/OFF

A remote ON/OFF control circuit is provided which is isolated from the input side, as well as, the output side. (Isolation withstand voltage: 1.5kV)

Connection of remote ON/OFF terminal is shown in the Figure 14. Output voltage turns remote on when current is made to flow through remote ON/OFF terminal. Remote ON/OFF terminal can be controlled by opening or closing connections (with switch or relay).

Maximum source current for remote ON/OFF terminal is 5mA. Therefore, current limiting resistor value must be set such that this maximum source current value is not exceeded. Also, the allowable maximum reverse current flow is 5mA.

Controlling the remote ON/OFF terminal from the input side

Connect current limiting resistor R1 as shown in Figure 14.

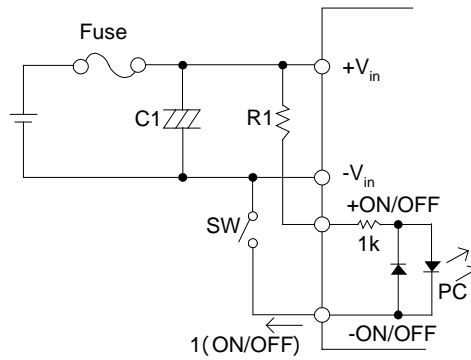

Figure 14 Connection of remote ON/OFF control (A)

R1: Recommended resistor value: 10kΩ (1W)

Controlling the remote ON/OFF terminal from the output side

Connect the current limiting resistor R1 as shown in Figure 15.

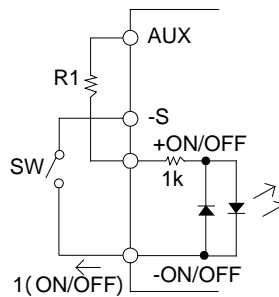

Figure 15 Connection of remote ON/OFF control (B)

R1: Recommended resistor Value: 2kΩ (1/2W)

Note:

1. A decoupling capacitor of about 0.1μF between the +remote ON/OFF terminal and –remote ON/OFF terminal is needed when input wiring is too long.
2. Current limiting resistor can also be connected to the –remote ON/OFF terminal side.

| Remote ON/OFF level | Output status |
|--------------------------|---------------|
| Open (<100μA) | Remote OFF |
| 1.5mA ≤ I (ON/OFF) ≤ 5mA | Remote ON |

Trim Characteristics

The output voltage of the converter can be trimmed using the trim pin provided. Connecting an external resistor between Trim pin and V_{o-} pin will decrease the output voltage, while connecting it between +S and V_{o+} will increase the output voltage. Trimming down more than 50% and trimming up more than 18% can cause the module to regulate improperly. If the trim pin is not needed, it should be left open.

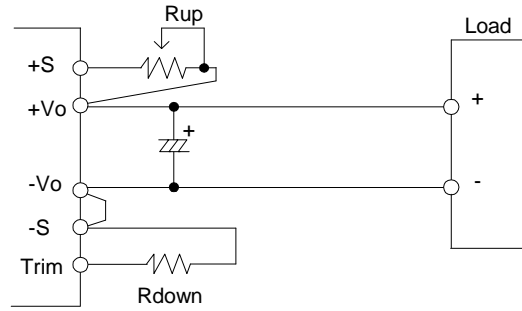

Figure 16 Trim circuit

$$R_{up} = 28 \left(\frac{V_o - V_e}{V_e} \right) k\Omega$$

$$R_{down} = -5.97 \left(\frac{V_o}{V_o - V_e} \right) k\Omega$$

V_e is the rated output voltage and V_o is the goal voltage.

For example, to get 30V output, the resistor is:

$$R_{up} = 28 \left(\frac{30 - 28}{28} \right) k\Omega = 2k\Omega$$

For another example, to get 14V output, the resistor is:

$$R_{down} = -5.97 \left(\frac{14}{14 - 28} \right) k\Omega = 5.97k\Omega$$

Note: Input voltage should be limited when output voltage increases, shown in the following figure.

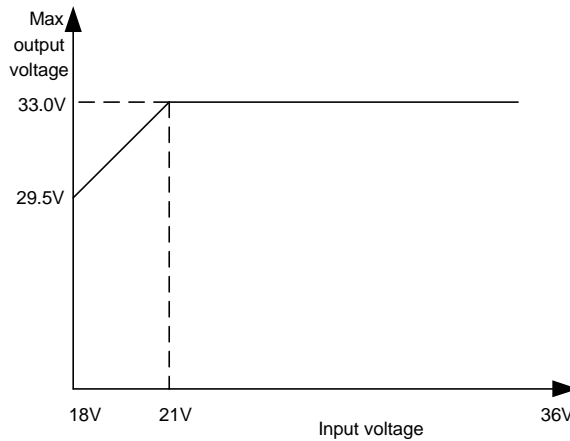

Figure 17 Trim-up voltage vs. input voltage

Sense Characteristics

If the load is far from the unit, connect S+ and S- to the terminal of the load respectively to compensate the voltage drop on the transmission line. See Figure 13.

If the sense compensate function is not necessary, short S+ to V_o+ and S- to V_o- respectively.

Input Ripple & Inrush Current and Output Ripple & Noise Test Configuration

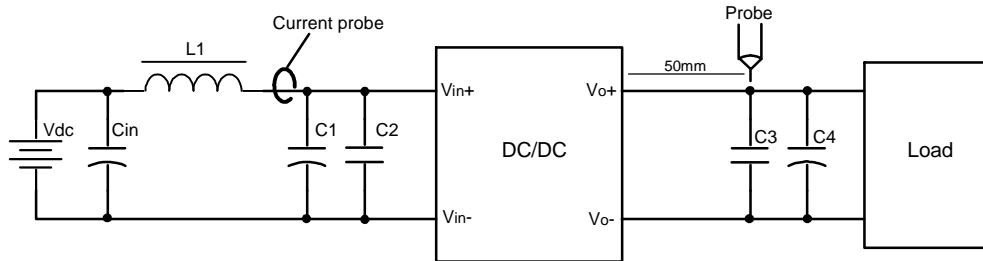

Figure 18 Input ripple & inrush current, ripple & noise test configuration

Vdc: DC power supply

L1: 12μH

Cin: 220μF/100V typical.

C1 ~ C4: See Figure 13

Note: Using a coaxial cable with series 50Ω resistor and 0.68μF ceramic capacitor or a ground ring of probe to test output ripple & noise is recommended.

EMC Filter Configuration

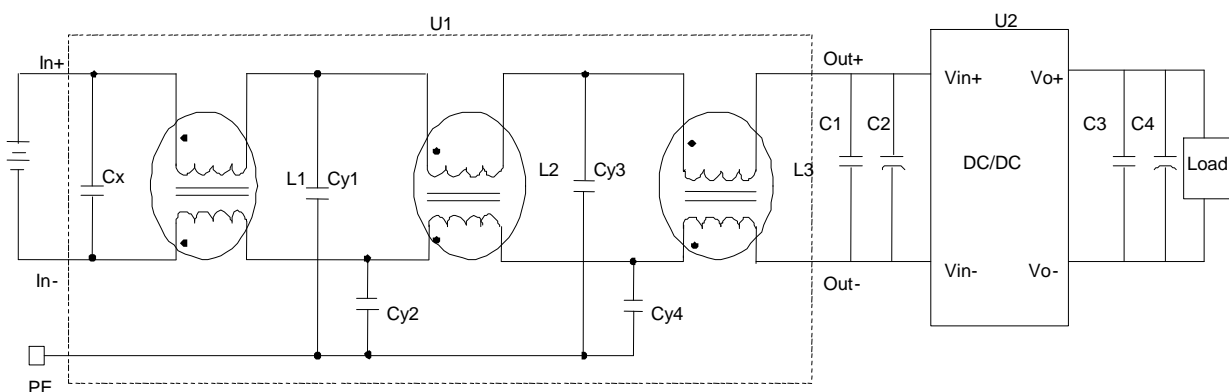

Figure 19 EMC test configuration

C_x: 5.7μF/100V capacitor

Cy1, Cy2, Cy3, Cy4: 4700pF, Y capacitor

L1, L2, L3: 100μH, common mode inductor

C1: 1500μF/50V electrolytic capacitor, P/N: UPW2A471MHD (Nichicon) or equivalent caps

C2 ~ C4: See Figure 13

U1: 40A input EMC filter module (P/N: FM100-40)

U2: Module under test, AGF600-24S28

Mechanical Diagram

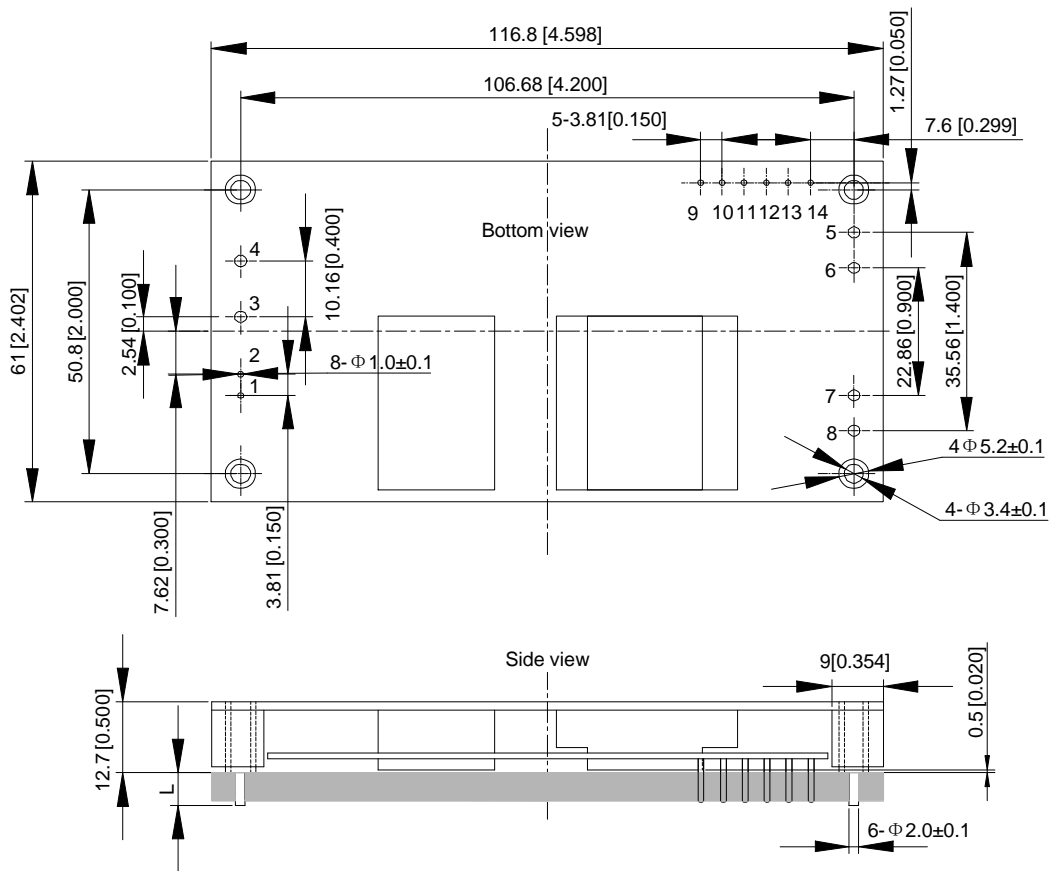

Unit: mm[inch] Bottom view: pin on upside
 Tolerance: X.Xmm±0.5mm[X.X in.±0.02in.]
 X.XXmm±0.25mm[X.XX in.±0.01in.]

Figure 20 Mechanical diagram

Pin length option

| Device code suffix | L |
|--------------------|-------------|
| -4 | 4.8mm±0.2mm |
| -6 | 3.8mm±0.2mm |
| -8 | 2.8mm±0.2mm |
| None | 5.8mm±0.2mm |

Pin Designations

| Pin NO. | Name | Function |
|---------|------------------|-------------------------|
| 1 | +On/Off | Remote control |
| 2 | -On/Off | Remote control |
| 3 | V _{in+} | Positive input voltage |
| 4 | V _{in-} | Negative input voltage |
| 5, 6 | V _{o-} | Negative output voltage |
| 7, 8 | V _{o+} | Positive output voltage |
| 9 | AUX | Auxiliary voltage |
| 10 | I OG | Inverter operation good |
| 11 | PC | Parallel operation |
| 12 | Trim | Trim terminal |
| 13 | +S | Remote sensing + |
| 14 | -S | Remote sensing - |

Soldering

The product is intended for standard manual or wave soldering.

When wave soldering is used, the temperature on pins is specified to maximum 260°C for maximum 7s.

When soldering by hand, the iron temperature should be maintained at 300°C ~ 380°C and applied to the converter pins for less than 10s. Longer exposure can cause internal damage to the converter.

Cleaning of solder joint can be performed with cleaning solvent IPA or simulative.

Thermal Considerations

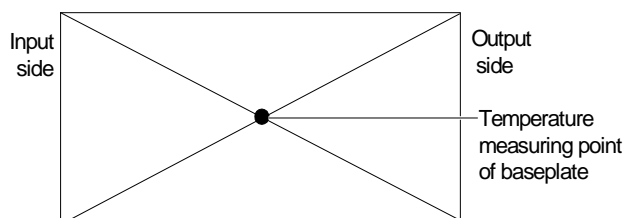

Figure 21 Temperature test point on base plate

Ordering Information

| AGF600 | - | 24 | S | 28 | - | 6 | L |
|--------------------------|---|--------------------------|--------------------------|--------------------------|---|--------------------------|--------------------------|
| <input type="checkbox"/> | | <input type="checkbox"/> | <input type="checkbox"/> | <input type="checkbox"/> | | <input type="checkbox"/> | <input type="checkbox"/> |

| | | |
|--------------------------|----------------------|--|
| <input type="checkbox"/> | Model series | AGF: high efficiency full brick series; 600: output power 600W |
| <input type="checkbox"/> | Input voltage | 24: 18V ~ 36V input range, rated input voltage 24V |
| <input type="checkbox"/> | Output channel | S: single output |
| <input type="checkbox"/> | Rated output voltage | 28: 28V output |
| <input type="checkbox"/> | Pin length | -6: 3.8mm |
| <input type="checkbox"/> | RoHS status | L: RoHS, R6; Y: RoHS, R5 |

| Model number | Description |
|-----------------|--|
| AGF600-24S28-6L | 3.8mm pin length; without thread inside mounting hole; R6 compliat |
| AGF600-24S28-6Y | 3.8mm pin length; without thread inside mounting hole; R5 compliat |

Hazardous Substances Announcement (RoHS of China)

| Parts | Hazardous substances | | | | | |
|-----------------|----------------------|----|----|-------|-----|------|
| | Pb | Hg | Cd | Cr6 + | PBB | PBDE |
| AGF600-24S28-6L | ○ | ○ | ○ | ○ | ○ | ○ |
| AGF600-24S28-6Y | √ | ○ | ○ | ○ | ○ | ○ |

○: Means the content of the hazardous substances in all the average quality materials of the part is within the limits specified in SJ/T-11363-2006

√: Means the content of the hazardous substances in at least one of the average quality materials of the part is outside the limits specified in SJ/T11363-2006

Emerson Network Power Co., Ltd. has been committed to the design and manufacturing of environment-friendly products. It will reduce and eventually eliminate the hazardous substances in the products through unremitting efforts in research. However, limited by the current technical level, the following parts still contain hazardous substances due to the lack of reliable substitute or mature solution:

1. Solders (including high-temperature solder in parts) contain plumbum.
2. Glass of electric parts contains plumbum.
3. Copper alloy of pins contains plumbum