

DS460S-3

460 Watts Distributed Power System

Total Power: 460 Watts
Input Voltage: 90-264 Vac
of Outputs: Main + Standby

Special Features

- Active power factor correction
- EN61000-3-2 harmonic compliance
- Active AC inrush control
- 1U X 2U short form factor
- +12 Vdc Output
- +12 Vdc stand-by
- Hot plug operation
- N + 1 redundant
- High efficiency redundancy
- Active current sharing
- Built-in cooling fan
- I²C communication interface bus
- PMBus™ compliant
- EERPOM for FRU data
- Two years warranty

Safety

UL/cUL 60950 (UL Recognized)
NEMKO 60950
CB Certificate and report
CE Mark (LVD)



Product Descriptions

The DS460S-3 series high-efficiency bulk front-end power supply is intended for systems that use distributed power architectures. Rated at 460 watts, the DS460S-3 power supply generates a main payload output of 12 Vdc and an auxiliary output of 12 Vdc for powering standby circuitry. These power supplies are digitally programmable – they are equipped with an I²C interface and use the industry-standard PMBus™ communications protocol.

The DS460S-3 power supply is intended primarily for use in rack-mounting server type applications, such as data centers. The power supply uses an advanced power conversion topology to maximize efficiency and have exceptionally compact form factors; these models have a height of just 1.6 inches, which makes them ideal for use in 1U high rack-mounting equipment.

DS460S-3 power supply features a wide 90 to 264 Vac input voltage range and employs active power factor correction to minimize input harmonic current distortion and to ensure compliance with the international EN61000-3-2 standard – they have a power factor of 0.99 typical.

The supply has a 1U x 2U form factor – it measures only 7.75 inches in length, ideally suitable for length limited applications. When fed with a high line 230 Vac input, the DS460S-3 can achieve a very high – 92 percent typical conversion efficiency at 50 percent full load.

Model Numbers

Standard	Output Voltage	Minimum Load	Maximum Load	Stand-By Supply	Air Flow Direction
DS460S-3-002	12.3 Vdc	1A	36A	12V @2.3A	Normal (DC Connector to Handle)
DS460S-3-003	12.3 Vdc	1A	36A	12V @2.3A	Reversed (Handle to DC Connector)

Options

None

Electrical Specifications

Absolute Maximum Ratings

Stress in excess of those listed in the “Absolute Maximum Ratings” may cause permanent damage to the power supply. These are stress ratings only and functional operation of the unit is not implied at these or any other conditions above those given in the operational sections of this TRN. Exposure to any absolute maximum rated condition for extended periods may adversely affect the power supply’s reliability.

Table 1. Absolute Maximum Ratings:

Parameter	Model	Symbol	Min	Typ	Max	Unit
Input Voltage: AC continuous operation	All	$V_{IN,AC}$	90	-	264	Vac
Maximum Output Power (Main + Stand-by)	All	$P_{O,max}$	-	-	460	W
Isolation Voltage						
Input to outputs	All		-	-	2500	Vac
Input to safety ground	All		-	-	2500	Vac
Outputs to safety ground	All		-	-	500	Vdc
Ambient Operating Temperature	All	T_A	5	-	+50	°C
Cold Start-up Temperature	All models	T_{ST}	-10	-	-	°C
Storage Temperature	All models	T_{STG}	-40	-	+85	°C
Humidity (non-condensing)						
Operating	All models		5	-	95	%
Non-operating	All models		5	-	95	%
Altitude						
Operating	All models		-	-	10,000 ¹	feet
Non-operating	All models		-	-	50,000	feet

Note 1: Maximum ambient operating temperature linearly derated from 50°C at 5,000 feet above sea level to 40°C at 10,000 feet above sea level.

Input Specifications

Table 2. Input Specifications:

Parameter	Conditions	Symbol	Min	Typ	Max	Unit
Operating Input Voltage, AC	All	$V_{IN,AC}$	90	115/230	264	Vac
Input Vac Source Frequency	All	$f_{IN,AC}$	47	50/60	63	Hz
Maximum Input Current ($I_O = I_{O,max}$, $I_{VSB} = I_{VSB,Max}$)	$V_{IN,AC} = 100Vac$ $V_{IN,AC} = 180Vac$	$I_{IN,max}$	- -	- -	6.0 3.0	Aac
No Load Input Power ($V_O = on$, $V_{SB} = on$, $I_O = 0$, $I_{SB} = 0$)	$V_{IN,AC} = 115Vac$ $V_{IN,AC} = 230Vac$	$P_{IN,no-load}$	- -	- -	7.0 7.0	W
Harmonic Line Currents	All	THD	Per EN61000-3-2			
Power Factor	$I_O = I_{O,max}$ $V_{IN,AC} = 240Vac$	PF	0.99	-	-	
Startup Surge Current (Inrush) @ 25°C	$V_{IN,AC} = 230Vac$	$I_{IN,surge}$	-	-	30	A_{PK}
Input Fuse	Internal, L line 250V, Fast-Acting		-	-	10	A
Input AC Low Line Start-up Voltage	$I_O = I_{O,max}$	$V_{IN,AC-start}$	80	-	90	Vac
Input AC Undervoltage Lockout Voltage	$I_O = I_{O,max}$	$V_{IN,AC-stop}$	70	-	80	Vac
PFC Switching Frequency	All	$f_{SW,PFC}$	45		55	kHz
DCDC Switching Frequency	All	$f_{SW,DC-DC}$	125		145	kHz
Stand-By Output Switching Frequency	All	$f_{SW,VSB}$	120		140	kHz
Operating Efficiency @ 25°C	$V_{IN,AC} = 230 Vac$ $I_O = 0.5 I_{O,max}$, $I_{VSB} = 0$	η	-	92	-	%
Hold Up Time	$V_{IN,AC} = 115 Vac$ $P_O = P_{O,max}$	$t_{Hold-Up}$	10	-	-	mSec
Leakage Current to safety ground	($V_{IN,AC} = 240Vac$, $f_i = 50/60 Hz$)	$I_{IN,leakage}$	-	-	1.0	mA

Output Specifications

Table 3. Output Specifications:

Parameter	Condition	Symbol	Min	Typ	Max	Unit	
Output Voltage Set points	$I_O = 1A$	V_O	12.27	12.30	12.33	Vdc	
	$I_{VSB} = 0.1A$	V_{VSB}	11.95	12.00	12.05		
Output Static Regulation	Measure at mating connector	V_O	11.85	12.30	12.45	Vdc	
		V_{VSB}	11.40	12.00	12.6		
Output Ripple, pk-pk	Measured over a bandwidth of 0Hz to 20MHz	V_O	-	-	120	mV_{PK-PK}	
		V_{VSB}	-	-	120		
Output Current	Single supply	I_O	1	-	36	A	
		I_{VSB}	0	-	2.3		
	Dual supplies	I_O	2	-	65.5		
		I_{VSB}	0	-	2.3		
Dynamic Response	Peak Deviation	50% load change, maximum 0.5A/ μ Sec slew rate, Inclusive of the static load regulation	V_O	11.60	-	12.60	%
			V_{VSB}	10.80	-	13.20	
	Setting Time	All	-	-	100	μ Sec	
Max number of parallel units	In same chassis		-	-	8	unit	
Output Capacitance	Unconditionally Stable	V_O	2,200	-	22,000	μ F	
		V_{VSB}	200	-	1,000		

System Timing Specifications

Table 4. System Timing Specifications:

Label	Parameter	Min	Typ	Max	Unit
T1	AC input on to V_{SB} in regulation after AC has been removed for more than 5 seconds	800	-	1,300	mSec
T2	V_{SB} rise time, 0V to V_{SB} in regulation	10	-	30	mSec
T3	AC input on to V_O in regulation with PSON# asserted low	1,000	-	1,500	mSec
T4	V_O rise time, 0V to V_O in regulation	10	-	30	mSec
T5	V_{SB} in regulation to V_O in regulation at AC input turn on with PSON# low	50	-	300	mSec
T6	V_O in regulation to PSOK high	50	-	100	mSec
T7	Delay from AC input off to PSOK mid level	0	-	4	mSec
T8	AC input off to PSOK low at 460W output power	10	-	-	mSec
	AC input off to PSOK low at 230W output power	20	-	-	mSec
	AC input off to PSOK low at 115W output power	30	-	-	mSec
	AC input off to PSOK low at 57.5W output power	40	-	-	mSec
T9	AC input off to V_O or V_{SB} out of regulation at 460W output power at 90Vac input	10	-	-	mSec
	AC input off to V_O or V_{SB} out of regulation at 230W output power at 90Vac input	20	-	-	mSec
	AC input off to V_O or V_{SB} out of regulation at 115W output power at 90Vac input	30	-	-	mSec
	AC input off to V_O or V_{SB} out of regulation at 57.5W output power at 90Vac input	40	-	-	mSec
T10	V_O or V_{SB} falling from 90% nominal to <0.3V ($V_O \geq 1A$, $V_{SB} \geq 0.1A$)	-	-	500	mSec
T11	PSON# low to V_O in regulation when AC has been present for more than 5 seconds	10	-	30	mSec
T12	Delay from PSON# high to PSOK low	-	-	50	mSec

System Timing Specifications

Figure 1. System Timing Diagram:

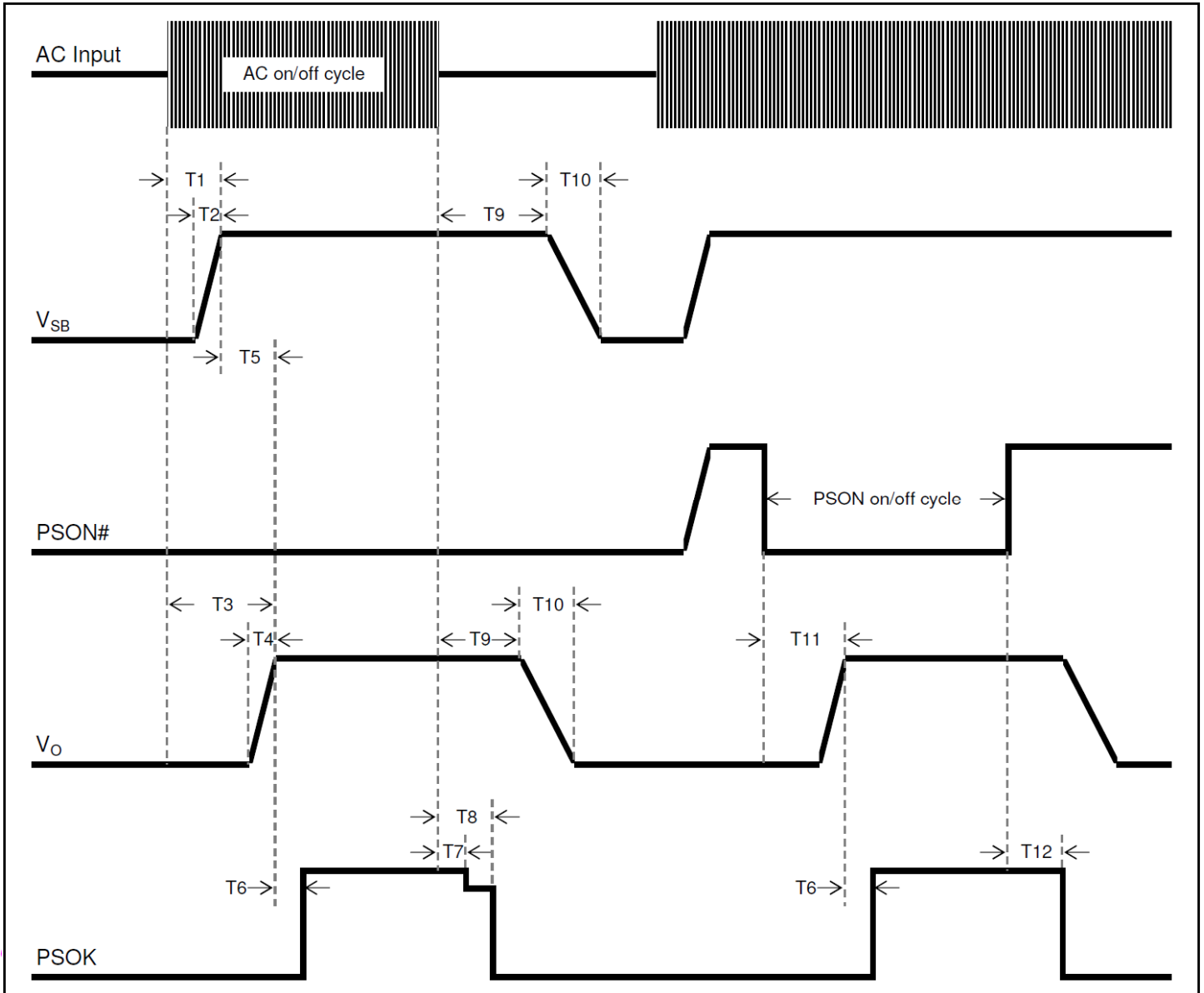

DS460S-3-002 Performance Curves

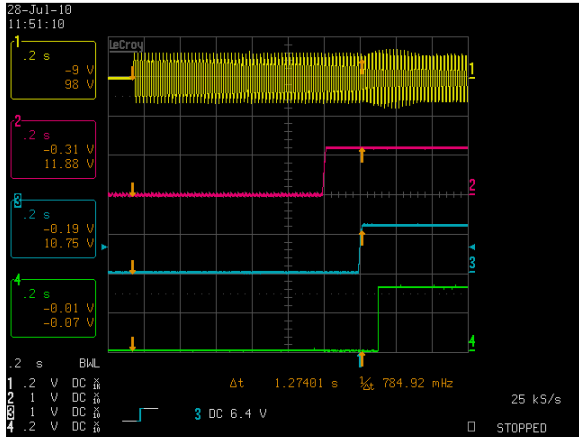

Figure 1: DS460S-3-002 Turn-on delay via AC mains – Vin = 90Vac
Full Load: Vo = 36A, VSB = 2.3A
Ch 1: AC Mains Ch 2: VSB Ch 3: Vo Ch 4: PSOK

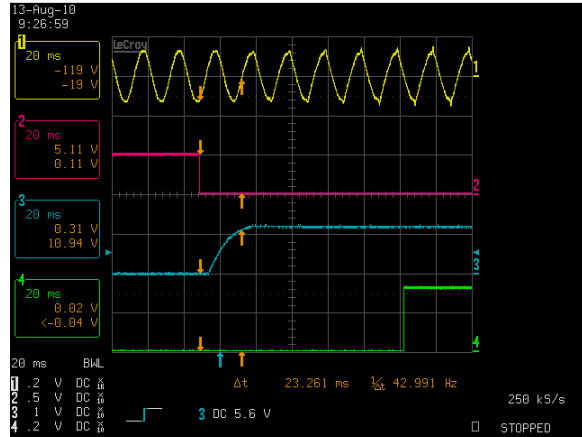

Figure 2: DS460S-3-002 Turn-on delay via PS_ON# – Vin = 90Vac
Full Load: Vo = 36A, VSB = 2.3A
Ch 1: AC Mains Ch 2: PS_ON# Ch 3: Vo Ch 4: PSOK

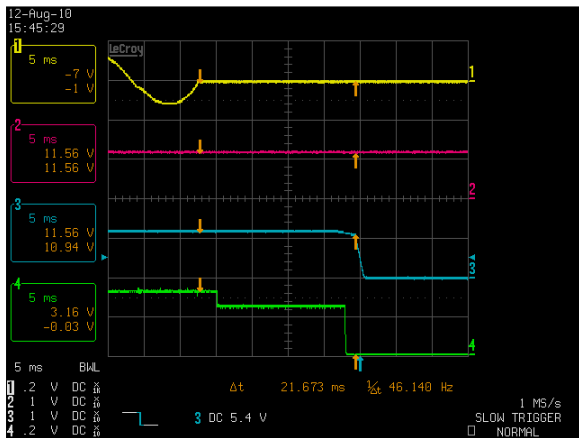

Figure 3: DS460S-3-002 Hold-up Time – Vin = 90Vac / 63Hz / 0°
Full Load: Vo = 36A, VSB = 2.3A
Ch 1: AC Mains Ch 2: VSB Ch 3: Vo Ch 4: PSOK

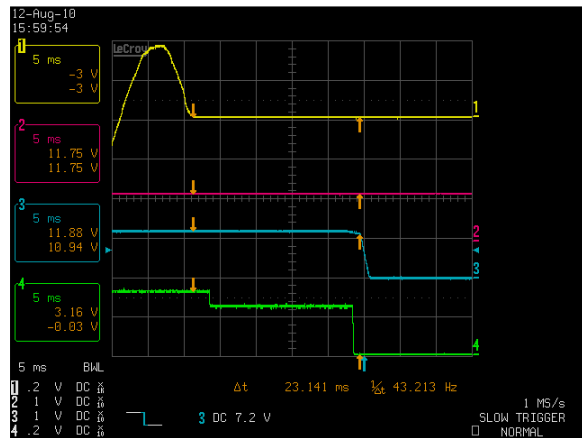

Figure 4: DS460S-3-002 Hold-up time – Vin = 264Vac / 47Hz / 0°
Full Load: Vo = 36A, VSB = 2.3A
Ch 1: AC Mains Ch 2: VSB Ch 3: Vo Ch 4: PSOK

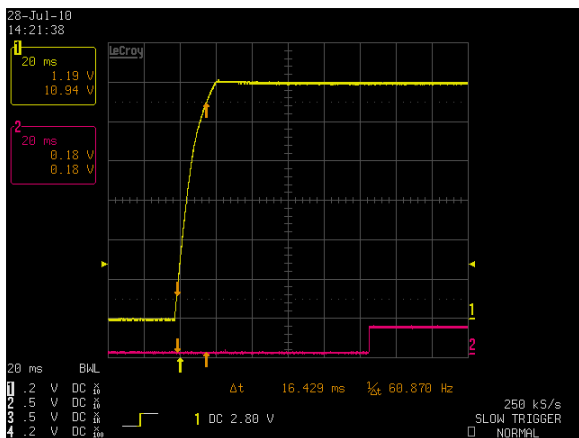

Figure 5: DS460S-3-002 Output Voltage Startup Characteristic – Vin = 90Vac
Full Load: Vo = 36A, VSB = 2.3A
Ch 1: Vo Ch 2: PSOK

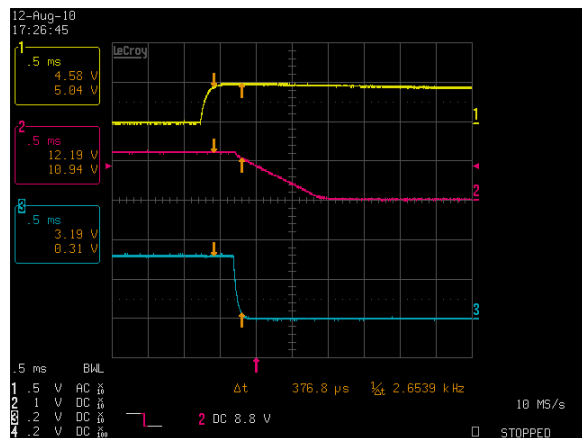

Figure 6: DS460S-3-002 Turn Off Characteristic via PS_ON
Full Load: Vo = 36A, VSB = 2.3A
Ch 1: PS_ON Ch 2: Vo Ch 3: PSOK

DS460S-3-002 Performance Curves

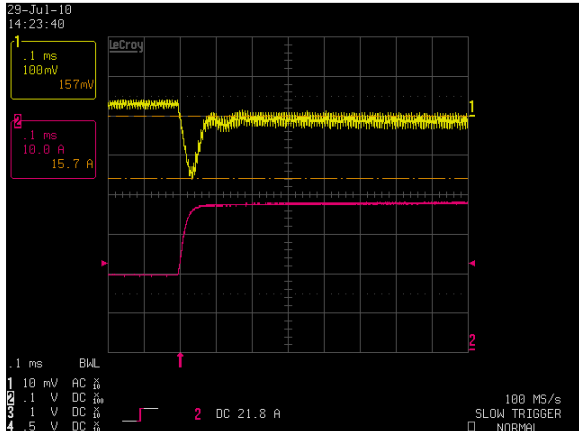

Figure 7: DS460S-3-002 Transient Response – Vo Deviation (low to high)
50% to 100% load change, 1A/ μ S slew rate, Vin = 230Vac
Ch 1: Vo
Ch 2: Io

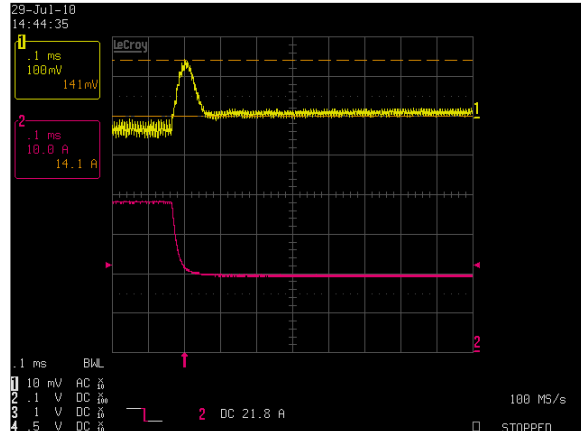

Figure 8: DS460S-3-002 Transient Response – Vo Deviation (high to low)
100% to 50% load change, 1A/ μ S slew rate, Vin = 230Vac
Ch 1: Vo
Ch 2: Io

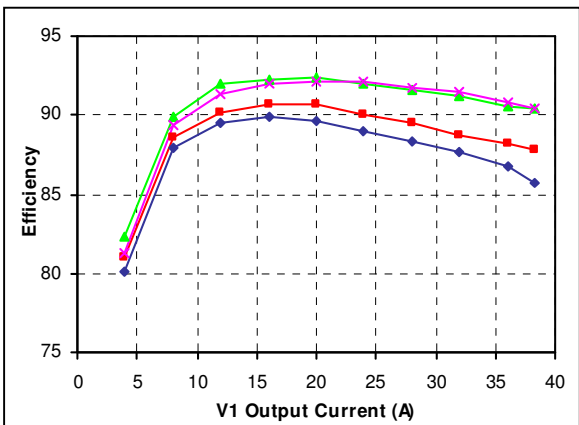

Figure 9: DS460S-3-002 Efficiency Curves @ 25 degC
 ◆ 90 Vac ■ 120 Vac ▲ 230 Vac ✕ 264 Vac
 Loading: V1 = 10% increment to 36A, 12VSB = 2.3A,

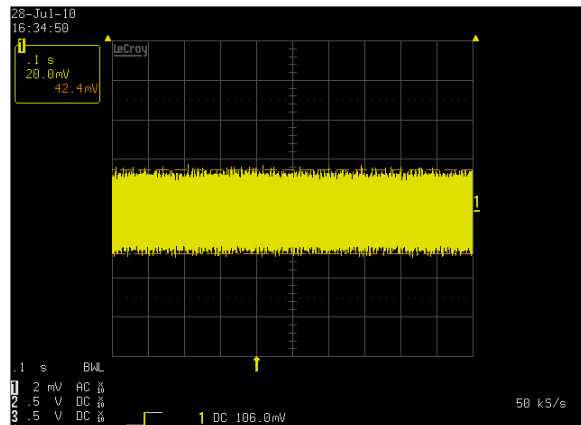

Figure 10: DS460S-3-002 Ripple and Noise Measurement – Vin = 90Vac
Full Load: Vo = 36A, VSB = 2.3A
Ch 1: Vo

Protection Function Specification

Input Fusing

DS460S-3 series is equipped with an internal non user serviceable 10A Fast-Acting Capacity 250Vac fuse to IEC 127 for fault protection in both the L1 and L2 lines input.

Over Voltage Protection (OVP)

The power supply latches off during output overvoltage on 12V output. it will shutdown in a retry hiccup mode during output overvoltage on the 12V_{SB} output. Toggling the PSON shall clear this latch# signal or by an AC input re-cycle.

Parameter	Min	Nom	Max	Unit
V _O Output Overvoltage	13.6	/	15.0	V
12V Standby Overvoltage	13.6	/	15.0	V

Over Current Protection (OCP)

DS460S-3 series includes internal current limit circuitry to prevent damage in the event of overload or short circuit. 12V over current protection shall be constant current type. Maximum short circuit current is limited only by the output load impedance and output voltage level during the short circuit. It is expected that the supply will self protect for any load over the maximum over current trip point. Over current limit level will be maintained for a period of 1 sec. minimum and 2 sec. maximum. After this time the power supply shall latch off. Toggling PSON shall clear the latch signal or by an AC input re-cycle. 12V_{SB} over current protection shall be hiccup (output re-try at a constant interval). A sustained overload shall not latch off 12V_{SB} output. 12V_{SB} over current limit level shall be maintained for a period of 100 msec. minimum and 500 msec. maximum.

Parameter	Min	Nom	Max	Unit
V _O Output Overcurrent	43.2	/	54	A
12V Standby Overcurrent	3.5	/	5	A

Over Temperature Protection (OTP)

The power supply is internally protected against over temperature conditions. When the OT circuit is activated, the power supply will shutdown. The 12V standby will not shutdown during an OTP condition on the main outputs. When the temperature drops to within safe operating limit for internal parts, the power supply will restore power automatically.

Mechanical Specifications

Mechanical Outlines (Unit: mm)

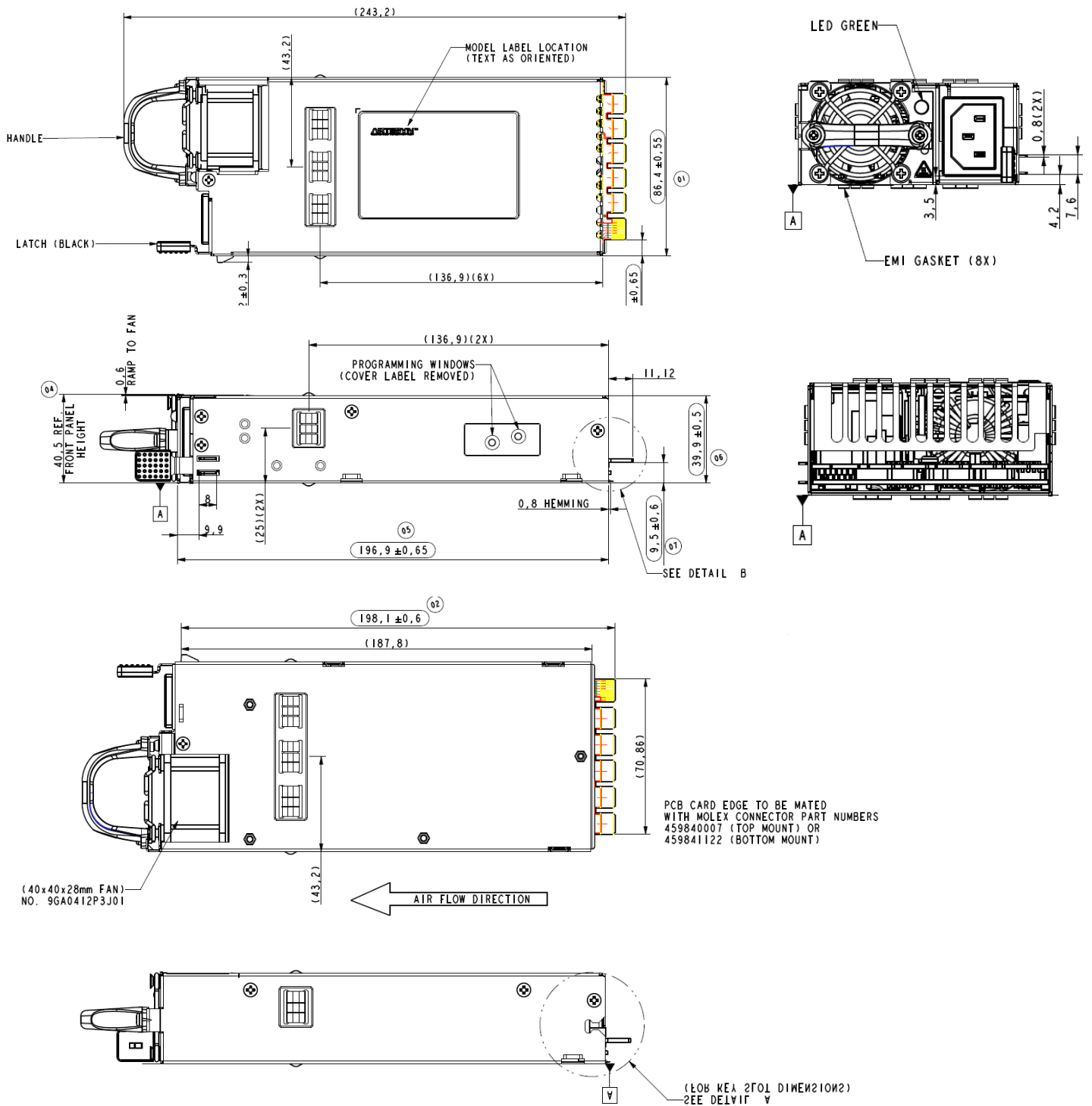

Connector Definitions

AC Input Connector

- Pin 1 – Line
- Pin 2 – Neutral
- Pin 3 – Earth Ground

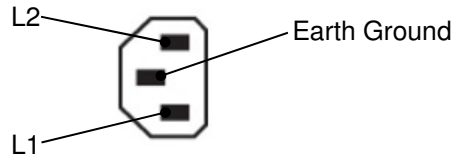

Output Connector – Power Blades

- PB1 – V_O
- PB2 – V_O
- PB3 – V_O
- PB4 – RTN
- PB5 – RTN
- PB6 – RTN
- PB7 – RTN
- PB8 – RTN
- PB9 – V_O
- PB10 – V_O

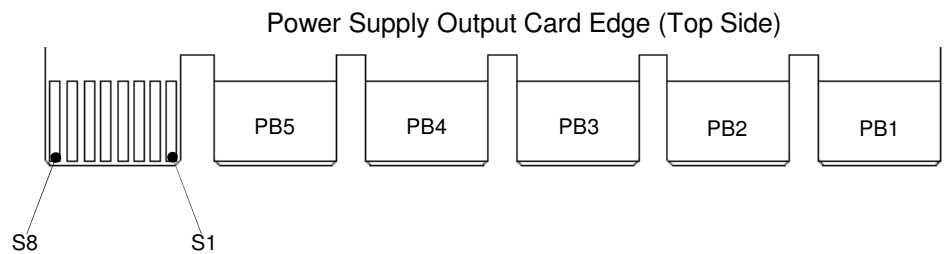

Output Connector – Signal Pins

- S1 – VSB
- S2 – VSB
- S3 – Reserved
- S4 – PS INTERRUPT
- S5 – PS PRESENT
- S6 – PSOK
- S7 – I-MON
- S8 – PSON#
- S9 – SCL
- S10 – SDA
- S11 – GND
- S12 – ADD0
- S13 – ADD1
- S14 – ADD2
- S15 – RTN
- S16 – RTN

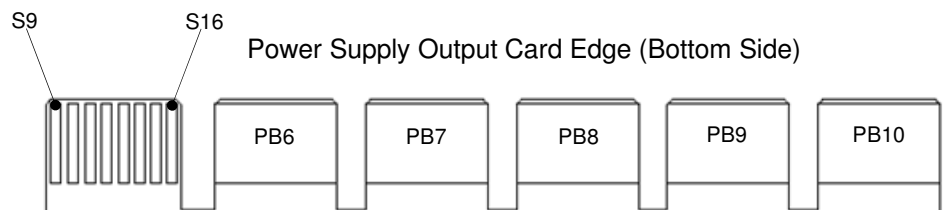

Power / Signal Mating Connectors and Pin Types

Table 5. Mating Connectors for DS460S-3 series

Reference	On Power Supply	Mating Connector or Equivalent
AC Input Connector	IEC320-C14	IEC320-C13
Output Connector	PCB card edge (0.062")	Molex 459840007 (top mount)
		Molex 459841122 (bottom mount)

LED indicator Definition

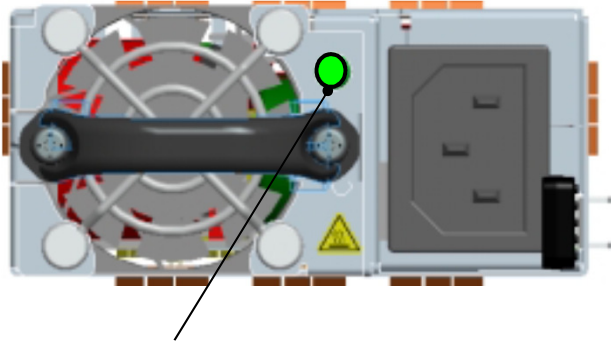

Status LED

One green LED at the power supply front provides status signal. The status LED conditions is shown on the below table.

Condition	LED Status
$V_{SB} = ON, V_O = OFF, AC\ Input = ON$	OFF
$V_{SB} = ON, V_O = ON$	Green
$V_O = OCP / UVP / OVP$	OFF
$FAN_FAULT / OTP / V_{SB} = OCP/UVP$	OFF

Weight

The DS460S-3 series weight is 1.88 lbs. maximum.

Environmental Specifications

EMC Immunity

DS460S-3 series power supply is designed to meet the following EMC immunity specifications:

Table 6. Environmental Specifications:

Document	Description
IEC 61000-4-2	ESD up to 4 kv contact, 8kv discharge
IEC 61000-4-3	RFI 3V/m
IEC 61000-4-4	Electrical Fast Transients level 3 minimum
IEC 61000-4-5	Surge level 3 minimum
IEC 61000-4-6	Radio frequency common mode, Levels 3V (rms) Modulated AM 80%. 1 kHz, 150 ohm source imp.
IEC 61000-4-11	AC Input transients >95% 0.5 period 30% 25 period>95% 250 period
IEC 61000-3-2	Harmonic Distortion

Safety Certifications

The DS460S-3 series power supply is intended for inclusion in other equipment and the installer must ensure that it is in compliance with all the requirements of the end application. This product is only for inclusion by professional installers within other equipment and must not be operated as a stand alone product. The DS460S-3 series has been designed in accordance with EN60950-1 'Safety of Information Technology Equipment'. The series also conforms with the provisions of the European Council Low Voltage Directive 73/23/EEC (as amended by 93/68/EEC) to bear the CE Mark.

Note, appropriate safety certificates and approvals are available to download from our website www.powerconversion.com.

Table 7. Safety Certifications for DS460S-3 series power supply system

Document	File #	Description
UL-60950-1 limited power clause latest edition	E186249, Vol.X6	Safety of information Technology Equipment
CSA C22.2 60950-1 limited power clause latest edition		Safety of information Technology Equipment
European Community Safety (certified to EN60950, A11 May 1996)	B100551485758	Investigated and marketed by TUV
CB Certificate and Report	E186249-A124-CB-1	(All CENELEC Countries)
CE Mark		LVD

EMI Emissions

The DS460S-3 series has been designed to comply with the Class A limits of EMI requirements of EN55022 (FCC Part 15) and CISPR 22 (EN55022) for emissions and relevant sections of EN61000 (IEC 61000) for immunity. The unit is enclosed inside a metal box, tested at 460W using resistive load with cooling fan.

Conducted Emissions

Table 8. Conducted EMI emission specifications of the DS460S-3 series

Parameter	Model	Symbol	Min	Typ	Max	Unit
FCC Part 15, class A	All	Margin	-	-	6	dB
VCCI Class II	All	Margin	-	-	6	dB
EN 60601-1-2: 2001	All	Margin	-	-	6	dB
CISPR 22 (EN55022) class A	All	Margin	-	-	6	dB

Radiated Emissions

Unlike conducted EMI, radiated EMI performance in a system environment may differ drastically from that in a stand-alone power supply. The shielding effect provided by the system enclosure may bring the EMI level to Class A. It is thus recommended that radiated EMI be evaluated in a system environment. The applicable standard is EN55022 Class A (FCC Part 15). Testing ac-dc convertors as a stand-alone component to the exact requirements of EN55022 can be difficult, because the standard calls for 1m leads to be attached to the input and outputs and aligned such as to maximize the disturbance. In such a set-up, it is possible to form a perfect dipole antenna that very few ac-dc convertors could pass. However, the standard also states that 'an attempt should be made to maximize the disturbance consistent with the typical application by varying the configuration of the test sample'.

Operating Temperature

The DS460S-3 series power supplies will start and operate within stated specifications at an ambient temperature from 5°C to 50°C under all load conditions with internal fan.

Forced Air Cooling

The DS460-3 series power supplies included internal cooling fans as part of the power supply assembly to provide forced air-cooling to maintain and control temperature of devices and ambient temperature in the power supply to appropriate levels. The standard direction of airflow is from the DC connector end to the AC connector end of the power supply.

The cooling fan is a variable speed fan. In standby mode power supply fan will operate at minimum speed to maintain component reliability at all load, line and ambient conditions. When 12V output is enabled, power supply fan will operate at minimum achievable fan speed. Power supply will contain fan speed control circuits to vary the speed so that the critical component temperatures do not exceed safe operating levels. Fans will be powered from voltage source inside the power supply and from system side voltage source.

- In redundant mode, 12V main power available, the fan in the power supply without input AC will operate at minimum speed, in an acceptable range of 1500 - 2000RPM, to avoid re-circulation of hot air through it.
- When the power supply is in standby mode, and no 12V main power is present, the fan will operate at minimum speed.
- If the supply enters power saver mode, 12VSB off, internal temperature sensors will control the fan.

When the inlet temperature is greater than $55 \pm 5^{\circ}\text{C}$, the power supply will increase the fan speed. Inlet temperature hysteresis for fan-closed control is $\pm 5^{\circ}\text{C}$. The power supply will increase the fan speed linearly to regulate the inlet temperature to prevent, or delay, an over temperature shutdown.

Storage and Shipping Temperature / Humidity

The DS460S-3 series power supplies can be stored or shipped at temperatures between $-40\text{ }^{\circ}\text{C}$ to $+85\text{ }^{\circ}\text{C}$ and relative humidity from 5% to 95% non-condensing.

Altitude

The DS460S-3 series will operate within specifications at altitudes up to 5,000 feet above sea level with no derating. Maximum inlet air temperature linearly derated from $50\text{ }^{\circ}\text{C}$ at 5,000 feet above sea level to $40\text{ }^{\circ}\text{C}$ at 10,000 feet above sea level. The power supply shall not be damaged when stored at altitudes of up to 50,000 feet above sea level.

Humidity

The DS460S-3 series will operate within specifications when subjected to a relative humidity from 5% to 95% non-condensing. The DS460S-3 series also can be stored in a relative humidity from 5% to 95% non-condensing.

Vibration

The DS460S-3 series power supply will pass the following vibration specifications:

Non-Operating Random Vibration

Acceleration	2.0	gRMS	
Frequency Range	10-500	Hz	
Duration	60	mins	
Direction	3 mutually perpendicular axis		
PSD Profile	FREQ 10-500 Hz	SLOPE dB/oct ---	PSD g²/Hz -0.008 g ² /Hz

Operating Random Vibration

Acceleration	1.0	gRMS	
Frequency Range	10-500	Hz	
Duration	60	mins	
Direction	3 mutually perpendicular axis		
PSD Profile	FREQ 10-500 Hz	SLOPE dB/oct ---	PSD g²/Hz -0.002 g ² /Hz

Shock

The DS460S-3 series power supply will pass the following vibration specifications:

Non-Operating Half-Sine Shock

Acceleration	-140	G
Duration	2	msec
Pulse	Half-Sine	
No. of Shock	3 shock on each of 6 faces	

Operating Half-Sine Shock

Acceleration	-5	G
Duration	11	msec
Pulse	Half-Sine	
No. of Shock	3 shock on each of 6 faces	

Power and Control Signal Descriptions

AC Input – IEC320 C14

This connector supplies the AC Mains to the DS460S-3 series power supply.

- Pin 1 - Line
- Pin 2 - Neutral
- Pin 3 - Earth Ground

Output Connector – Power Blades

These Power Blades provide the main output for the DS460S-3. The V_O and the TRN blades are the positive and negative rails, respectively, of the main output of the DS460S-3 power supply. The RTN rail is electrically connected to the power supply chassis.

- PB1 - V_O
- PB2 - V_O
- PB3 - V_O
- PB4 - RTN
- PB5 - RTN
- PB6 - RTN
- PB7 - RTN
- PB8 - RTN
- PB9 - V_O
- PB10 - V_O

Control Connector – Signal Pins

The DS460S-3 contains a 16 pins control signal header providing control signal interface and standby power interface.

VSB (StandBy Voltage) – (pin S1, S2)

The DS460S-3 provides a regulated 12 volt 2.3 amp auxiliary output voltage to power critical circuitry that must remain active regardless of the on/off status of the power supply's main output. The VSB standby voltage is available whenever a valid AC input voltage is applied to the unit. The VSB output is independently short circuit protected and is referenced to the RTN pins (S15 & S16).

PS INTERRUPT – (pin S4)

The signal behavior in response to certain operating condition changes in the power supply as defined in the Firmware Specification section. This signal shall be pulled up to maximum 5V logic level external to the PS.

PS PRESENT (Power Supply Present) – (pin S5)

PS PRESENT signal is used to sense the number of power supplies in the system (operational or not) and provide hot plug insertion and removal functionality by controlling main outputs during hot plug insertion and removal by employing following circuitry. When the unit is removed from the system the fast shut down signal quickly turns OFF main outputs and discharges output capacitors.

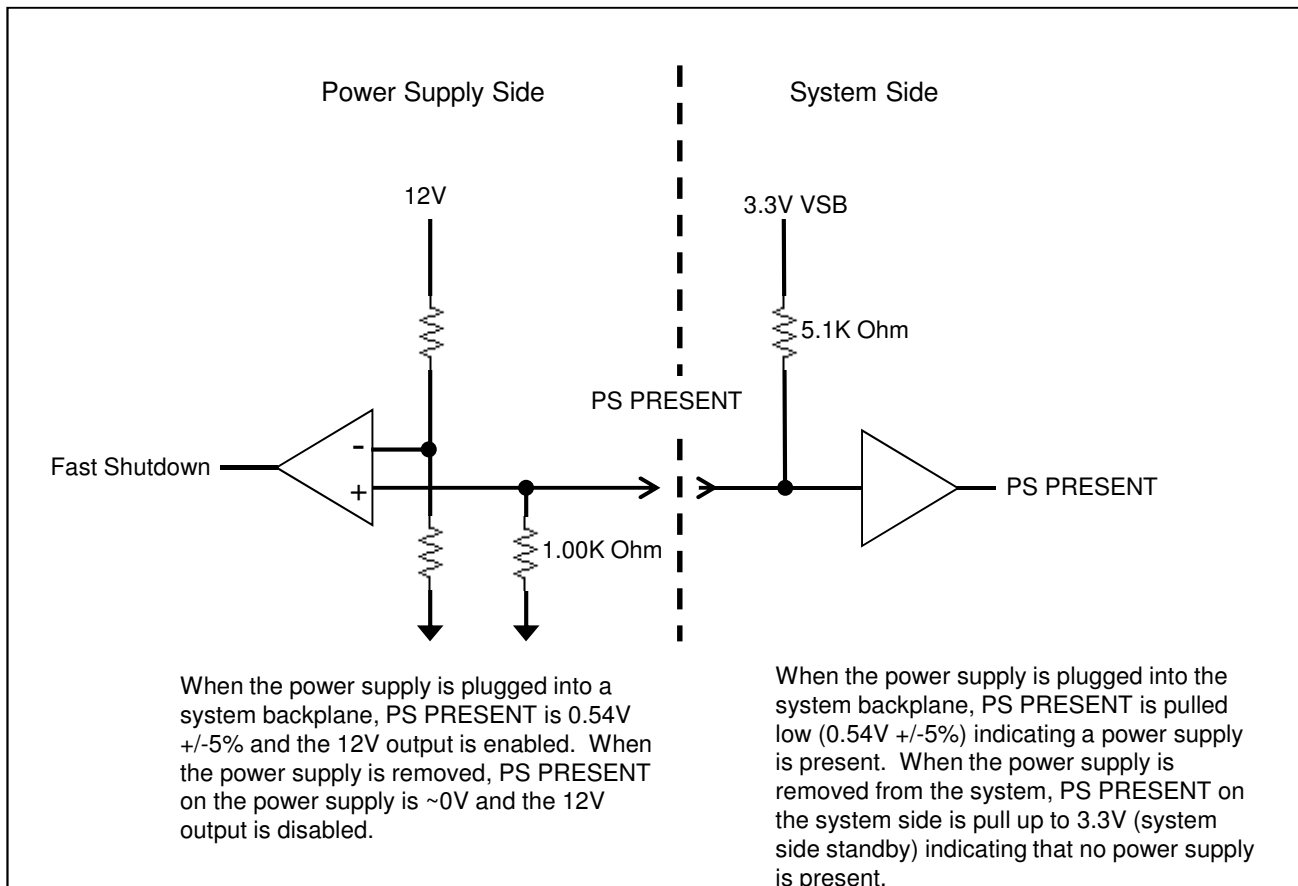

PRESENT# SIGNAL CHARACTERISTICS:

SIGNAL TYPE	Output From Power Supply, Pull-Up to 3.3VSB with 5.1K in System	
PRESENT# = Low	Present	
PRESENT# = High	Not Present	
	MIN	MAX
Logic level low voltage	0V	0.6V
Logic level high voltage, sink=50uA	1.0V	3.3V
12V Output enable threshold	350mV	
12V output disable threshold	150mV	250mV
Sink current, PRESENT# = low		1mA
Signal transition time. Transition is defined as period during system insertion or removal as the Present pin makes or breaks contact with a powered system.		200usec

PSOK (Output OK Indicator) – (pin S6)

PSOK is a combined indicator of AC input and main 12V DC output. This is a three level signal to indicate different stages as follows.

- AC not OK and DC not OK – Signal status shall be LOW (<0.6V)
- AC OK and DC not OK – Signal status shall be LOW (<0.6V)
- AC OK and DC OK – Signal status shall be HIGH (> 3.0V)
- AC not OK and DC OK – Signal status shall be Middle Level (Between 2V and 2.5V)

DC OK threshold is defined as when the 12V output is greater than 11.5V.

DC not OK threshold is defined as when the 12V output is less than 11.4V and greater than 11.3

PSOK SIGNAL CHARACTER/STLC:

Signal Type	Accepts an open co	
PSOK = High	PS Good	
PSOK = Low	PS Not Good	
PSOK = MID	AC Bad, DC Good	
	MIN	MAX
Logic level low	0V	0.6V
Logic level mid voltage	2.0	2.5
Logic level high	3.0V	3.3V
Sink current, PSOK = low		1mA
Source current, PSOK =mid		200uA
Source current, PSOK = high		1mA
Signal rise and fall time		200usec

I-Mon (Current Monitor) – (pin S7)

I-Mon signal provides 12V output current information. Signal characteristic is defined in below table.

I-MONITOR OUTPUT CHARACTERISTIC:

ITEM	DESCRIPTION	MIN	NOMINAL	MAX	UNITS
Vshare; Iout= 45.96A	Voltage of load monitor bus.	3.88	4.00	4.12	V
Vshare; Iout= 36A	Voltage of load monitor bus.	3.23	3.33	3.43	V
Vshare; Iout= 22.98A	Voltage of load monitor bus.	1.94	2.00	2.06	V
Vshare; Iout= 9.19A	Voltage of load monitor bus.	0.76	0.8	0.84	V
Vshare; Iout= 2.3A	Voltage of load monitor bus.	0.16	0.2	0.24	V
Vshare; Iout= 0A	Voltage of load monitor bus.	-0.2	0	0.2	V
$\Delta V_{share}/\Delta I_{out}$; Iout>0.5A	Slope of load monitor bus voltage with changing load.		4 / Ioutmax		V / A
Ishare sink; Vshare=4V	Amount of current the load monitor bus output from each power supply sinks.			0.25	mA
I share source; Vshare=4V	Amount of current the load monitor bus output from each power supply sources.	2.0			mA
Treponse	Delay from output current transition to I-monitor signal change			500	usec

PSO# (Power Supply ON) – (pin S8)

PSO# signal is required to remotely turn on/off the power supply. PSO# is an active low signal that turns on the main 12V DC output. When this signal is not pulled low by the system, or left open, the 12V output is turned off. This signal is pulled to a standby voltage by a pull-up resistor internal to the power supply. Refer to below On/Off Timing for timing diagram. When in off or standby condition, the main 12V DC output will be less than 50mV with respect to output return.

PSO# SIGNAL CHARACTERISTICS:

Signal Type	Accepts an open co	
PSO# = Low	ON	
PSO# = Open	OFF (Not installed in the system)	
	MIN	MAX
Logic level low (power supply ON)	0V	0.8V
Logic level high (power supply OFF)	2.0V	3.30V
Source current, Vpsn = Low		1mA
Signal rise and fall time		200usec

RTN (Output Return) – (pin S15, S16)

Power return for the standby voltage VSB, electrically connected to the main VO 12VDC output return RTN of the power blades

Communication Bus Descriptions

I²C Bus Signals

The DS460S-3 power supply contains enhanced monitor and control functions implemented via the I²C bus. The DS460S-3 I²C functionality (PMBus™ and FRU data) can be accessed via the output connector control signals. The communication bus is powered either by the internal 5V supply or from an external power source connected to the StandBy Output (ie: accessing an unpowered power supply as long as the StandBy Output of another power supply connected in parallel is on).

If units are connected in parallel or in redundant mode, the StandBy Outputs must be connected together in the system. Otherwise, the I²C bus will not work properly when a unit is inserted into the system without the AC source connected.

Note: PMBus™ functionality can be accessed only when the PSU is powered-up.
Guaranteed communication I²C speed is 100KHz.

SCL, SDA (I²C Serial Clock and Data) – (pin S9, S10)

I²C serial data and clock bus - these pins are internally pulled up to internal uC_VCC with a 20K resistor. These pins must be pulled-up in the system by an 3.3KΩ to 10KΩ pull-up resistors for the SDA and SCL lines to 5Vsb or an appropriate VCC derived from 12VSB.

ADD0, ADD1, ADD2 (PS Address lines A0, A1, A2) – (pin S12, S13, S14)

Address pins ADD0, ADD1 and ADD2 are used by end use system to allocate unit address to a power supply in particular slot position. These lines are pulled up to 5V logic level internal to the PS. The end user system must pull these lines low via 300Ω or less or leave it floating to assign the I²C address of the power supply.

GND (I²C Signal Ground) – (S11)

Ground reference for I²C signals SCL and SDA

I²C Bus Communication Interval

The interval between two consecutive I²C communications to the power supply should be at least 50ms to ensure proper monitoring functionality.

I²C Bus Signal Integrity

The noise on the I²C bus (SDA, SCL lines) due to the power supply will be less than 500mV peak-to-peak. This noise measurement should be made with an oscilloscope bandwidth limited to 100MHz. Measurements should be made at the power supply output connector with 3.2K ohm resistors pulled up to StandBy Output and 20pf ceramic capacitors to StandBy Output Return.

The noise on the address lines ADD0 ADD1 and ADD2 will be less than 100mV peak-to-peak. This noise measurement should be made at the power supply output connector.

I²C Bus Internal Implementation, Pull-ups and Bus Capacitances

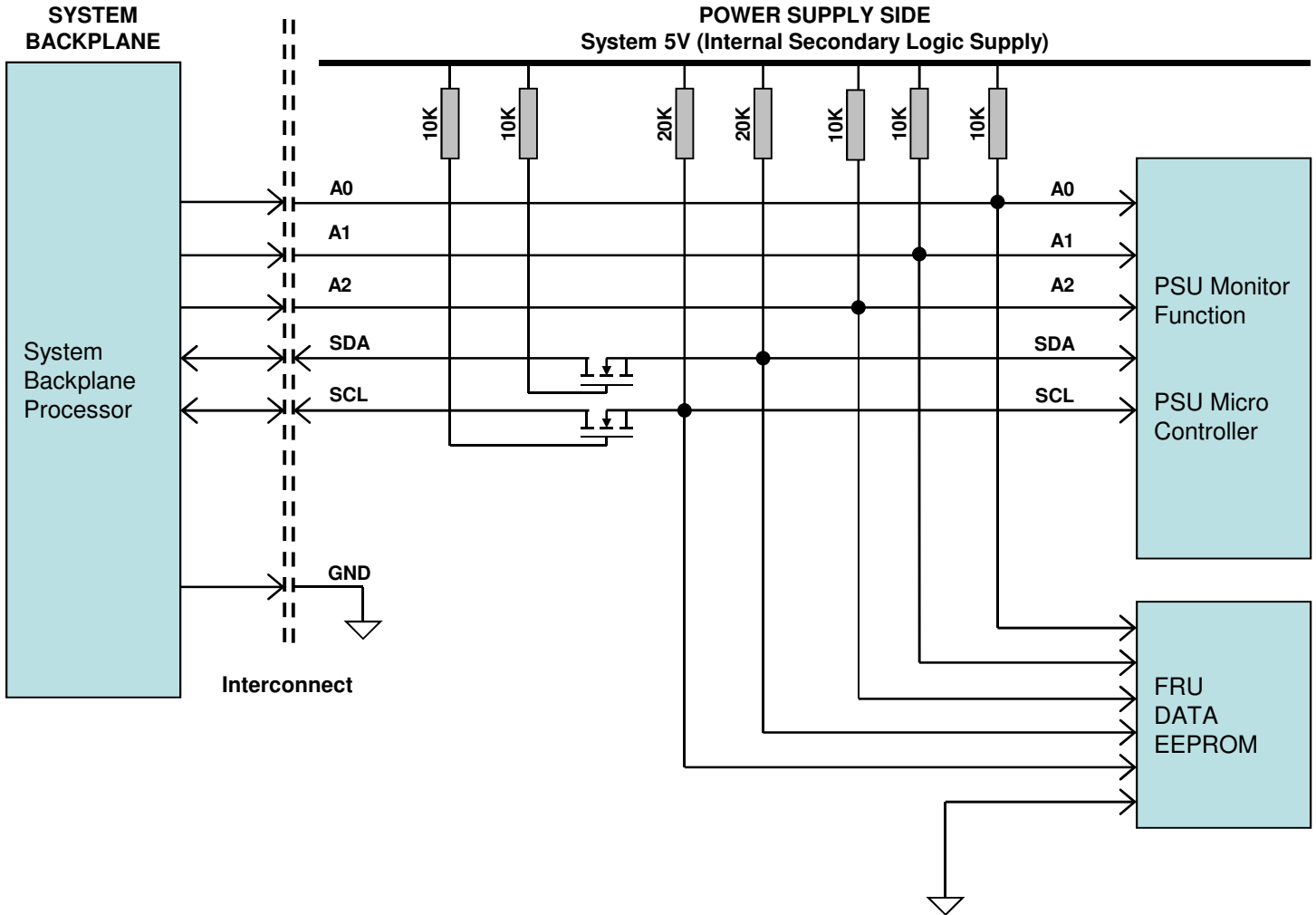

I²C Bus - Recommended external pull-ups:

Electrical and Interface specifications of I²C signals (referenced to StandBy Output Return pin, unless otherwise indicated):

Parameter	Condition	Symbol	Min	Typ	Max	Unit
SDA, SCL internal pull-up resistor		R_{int}	-	20	-	Kohm
SDA, SCL internal bus capacitance		C_{int}	-	0	-	pF
Recommended external pull-up resistor 1 PSU	1 PSU	R_{ext}	3.3	-	10	Kohm
	8 PSU		0.41	-	1.25	Kohm

Logic Levels

DS460S-3 series power supply I²C Communication Bus will respond to logic levels as per below:

Logic High: 5.1V Nominal (Specs is 2.1V to 5.5V)**

Logic Low: 500mV nominal (Specs is 800mV max)**

** Note: Philips™ I²C adapter was used.

Timings

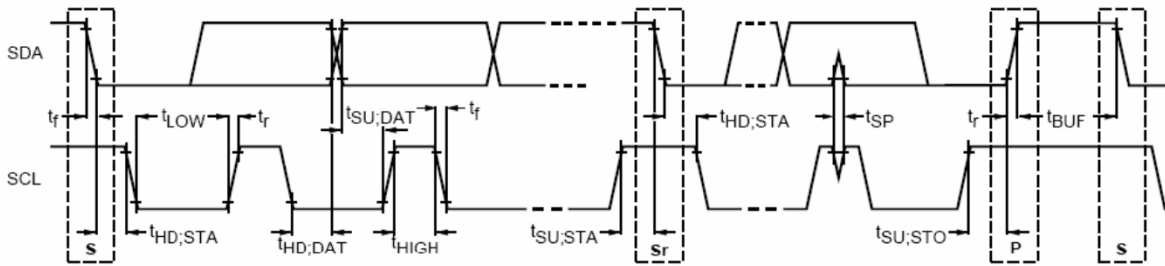

Parameter	Symbol	Standard-Mode Soecs		Actual		Unit
		Min	Max			
SCL Clock Frequency	f_{SCL}	10	100	98		kHz
Hold time (repeated) START condition	$t_{HD;STA}$	4.0	-	4.892		us
LOW period of SCL clock	t_{LOW}	4.7	-	6.138		us
HIGH period of SCL clock	t_{HIGH}	4.0	50	4.077		us
Setup time for repeated START condition	$t_{SU;STA}$	4.7	-	5.617		us
Data hold time	$t_{HD;DAT}$	0	-	3.6		us
Data setup time	$t_{SU;DAT}$	250	-	4728		ns
Rise time	t_r	-	1000	SCL = 719	SDA = 868	ns
Fall time	t_f	-	300	SCL = 298	SDA = 163	ns
Setup time for STOP condition	$t_{SU;STO}$	4.0	-	5.28		us
Bus free time between a STOP and START condition	t_{BUF}	4.7	-	17.6***		us

*** Note Philips™ I²C adapter and bundled software (USB-to-I²C) was used

Device Addressing

The DS460S-3 series will respond to supported commands on the I²C bus that are addressed according to pins A2, A1 and A0 pins of CN403.

PMBus™ address is B, [logic combination of A2, A1 and A0].

FRU address is A, [logic combination of A2, A1 and A0].

Address pins are held HIGH by default via pull-up to 5V_I2C. Connect these pins to GND to set it logic LOW.

As an example, if the address pins were left unconnected, A2, A1 and A0 are logic High. Thus, addressing is as follows:

PMBus™ - B, [A2, A1, A0, 0] therefore, if left unconnected, B, [1,1,1,0] = BE (default PMBus™ Address)

FRU - A, [A2, A1, A0, 0] therefore, if left unconnected, A,[1,1,1,0] = AE (default FRU Address)

Important: The least significant bit of the address byte is always 0.

The I²C address of the device is based on the slot the PSU is in. The address is defined as follows:

Bus	PSU Slot	Slot ID Bits			PMBus™ Address	EEPROM (FRU) Address
		A2	A1	A0		
I2C_PSU1	1	0	0	0	B0	A0
I2C_PSU2	2	0	0	1	B2	A2
I2C_PSU3	3	0	1	0	B4	A4
I2C_PSU4	4	0	1	1	B6	A6
I2C_PSU5	5	1	0	0	B8	A8
I2C_PSU6	6	1	0	1	BA	AA
I2C_PSU7	7	1	1	0	BC	AC
I2C_PSU8	8	1	1	1	BE	AE

I²C Clock Synchronization

The DS460S-3 power supply might apply clock stretching. An addressed slave power supply may hold the clock line (SCL) low after receiving (or sending) a byte, indicating that it is not yet ready to process more data. The system master that is communicating with the power supply will attempt to raise the clock to transfer the next bit, but must verify that the clock line was actually raised. If the power supply is clock stretching, the clock line will still be low (because the connections are open-drain).

The maximum time out condition for clock stretching for DS460S-3 is 25 microseconds.

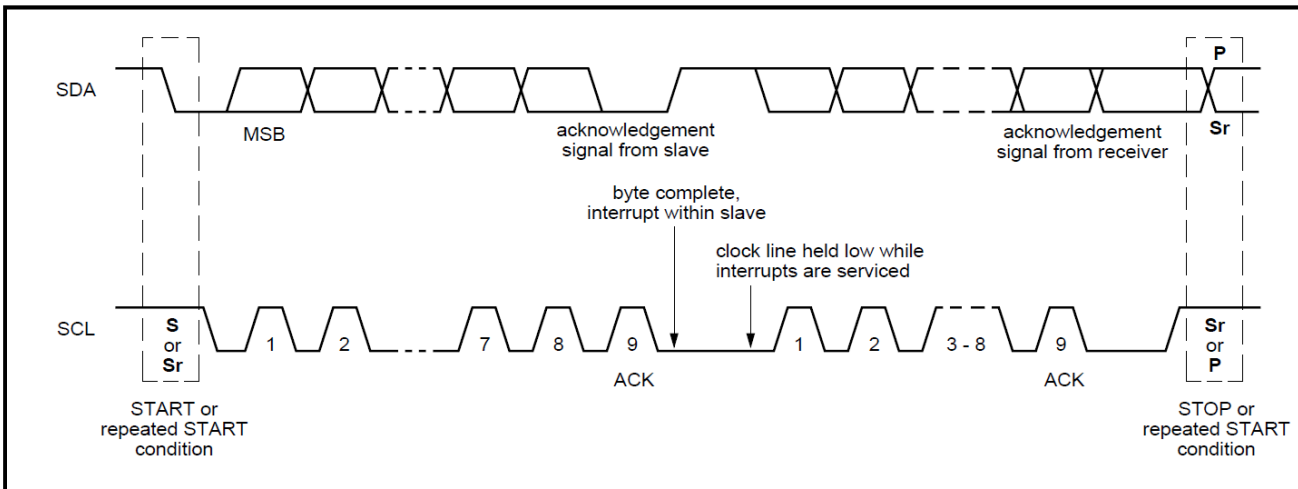

FRU (EEPROM) Data

The FRU (Field Replaceable Unit) data format compliant with the Intel IPMI v1.0 specification.

The DS460S-3 uses 1 page of EEPROM for FRU purpose. A page of EEPROM contains up to 256 byte-sized data locations.

- Where:
- OFFSET** - The OFFSET denotes the address in decimal format of a particular data byte within DS460S-3 EEPROM.
 - VALUE** - The VALUE details data written to a particular memory location of the EEPROM.
 - DEFINITION** - The contents DEFINITION refers to the definition of a particular data byte.

DS460S-3-002 FRU (EEPROM) Data:

OFFSET		DEFINITION	SPEC VALUE	
(DEC)	(HEX)	(REMARKS)	(DEC)	(HEX)
COMMON HEADER, 8 BYTES				
0	00	FORMAT VERSION NUMBER (Common Header) 7:4 - Reserved, write as 0000b 3:0 - Format Version Number = 1h for this specification	1	01
1	01	INTERNAL USE AREA OFFSET (In multiples of 8 bytes)	24	18
2	02	CHASSIS INFO AREA OFFSET (In multiples of 8 bytes)	1	01
3	03	BOARD INFO AREA OFFSET (In multiples of 8 bytes)	0	00
4	04	PRODUCT INFO AREA OFFSET (In multiples of 8 bytes)	5	05
5	05	MULTI RECORD AREA OFFSET (In multiples of 8 bytes)	15	0F
6	06	PAD (reserved – always 00H)	0	00
7	07	ZERO CHECK SUM (256 – (Sum of bytes 0 to 6))	210	D2
CHASSIS INFO AREA(32 BYTES) This area will be filled by the Mfg. Diag. or by the OS if used				
8	08	FORMAT VERSION NUMBER 7:4 - Reserved, write as 0000b 3:0 - Format Version Number = 1h for this specification	1	01
9	09	CHASSIS INFO AREA LENGTH (in multiple of 8 bytes)	0	00
10	0A	CHASSIS TYPE (Default value is 0.)	0	00
11	0B	CHASSIS PART NUMBER TYPE / LENGTH 10 Byte Allocation	0	00
12	0C	CHASSIS PART NUMBER BYTES (Default value is 0.)	0	00
13	0D		0	00
14	0E		0	00
15	0F		0	00
16	10		0	00
17	11		0	00
18	12		0	00
19	13		0	00
20	14		0	00
21	15		0	00
22	16	CHASSIS SERIAL NUMBER TYPE / LENGTH 15-Byte Allocation	0	00
23	17	CHASSIS SERIAL NUMBER BYTES , Default value is 0.	0	00
24	18		0	00
25	19		0	00
26	1A		0	00
27	1B		0	00
28	1C		0	00
29	1D		0	00
30	1E		0	00
31	1F		0	00
32	20		0	00

DS460S-3-002 FRU (EEPROM) Data:

OFFSET		DEFINITION	SPEC VALUE		
(DEC)	(HEX)	(REMARKS)	(DEC)	(HEX)	
33	20	CHASSIS SERIAL NUMBER BYTES, Default value is 0.	0	00	
34	22		0	00	
35	23		0	00	
36	24		0	00	
37	25		0	00	
38	26	END TAG	0	00	
39	27	ZERO CHECK SUM (CHASSIS INFO) [256d - (Sum of bytes 08d to 39d)]	255	FF	
PRODUCT INFORMATION AREA, 80 BYTES					
40	28	FORMAT VERSION NUMBER (Product Info Area) 7:4 - Reserved, write as 0000b 3:0 - Format Version Number = 1h for this specification	1	01	
41	29	PRODUCT INFO AREA LENGTH (In multiples of 8 bytes)	10	0A	
42	2A	Language (English)	25	19	
43	2B	MANUFACTURER NAME TYPE / LENGTH (0C5H) 7-6: (11)b, 8-Bit ASCII + Latin 1 5-0: (000101)b, 5-Byte Allocation	199	C7	
44	2C	MANUFACTURER'S NAME 5 byte sequence "E" = 45h "M" = 4Dh "E" = 45h "R" = 52h "S" = 53h "O" = 4Fh "N" = 4Eh	69	45	
45	2D		77	4D	
46	2E		69	45	
47	2F		82	52	
48	30		83	53	
49	31		79	4F	
50	32		78	4E	
51	33	PRODUCT NAME Type/Length (0CEH) 7-6: (11)b, 8-Bit ASCII + Latin 1, 5-0: (001110)b, 14-Byte Allocation	204	CC	
52	34	PRODUCT NAME "D" = 44h "S" = 53h "4" = 34h "6" = 36h "0" = 30h "S" = 53h "." = 2Dh "3" = 33h "- " = 2Dh "0" = 30h "0" = 30h "2" = 32h	68	44	
53	35		83	53	
54	36		52	34	
55	37		54	36	
56	38		48	30	
57	39		83	53	
58	3A		45	2D	
59	3B		51	33	
60	3C		45	2D	
61	3D		48	30	
62	3E		48	30	
63	3F		50	32	
64	40		PRODUCT NAME TYPE / LENGTH (0CD) 205 d CD H 7-6: (11)b, 8-Bit ASCII + Latin 1, 5-0: (001101)b, 13-Byte Allocation	205	CD
65	41		POWER SUPPLY SPARE KIT NUMBER Power Supply Spare Kit number 192201-001 NOT APPLICABLE	0	00
66	42	0		00	
67	43	0		00	
68	44	0		00	
69	45	0		00	
70	46	0		00	
71	47	0		00	
72	48	0		00	
73	49	0		00	
74	4A	0		00	

DS460S-3-002 FRU (EEPROM) Data:

OFFSET		DEFINITION	SPEC VALUE		
(DEC)	(HEX)	(REMARKS)	(DEC)	(HEX)	
75	4B		0	00	
76	4C		0	00	
77	4D		0	00	
78	4E	PRODUCT VERSION NUMBER TYPE / LENGTH (0C2H) 7-6: (11)b, 8-Bit ASCII + Latin1, 5-0: (000010)b, 2-Byte Allocation	194	C2	
79	4F	PRODUCT VERSION NUMBER / AUTO REV "0" = 30H "A" = 41H SHOULD TRACK MODEL REVISION indicated on IPS	48	30	
80	50		65	41	
81	51	PRODUCT SERIAL NUMBER TYPE / LENGTH (0CDH) 205 d CD H *PRODUCT SERIAL NUMBER IS BASED ON ASTEC SERIAL NUMBER FORMAT	205	CD	
82	52	P/N: 417-00201000 7-6: (11)b, 8-Bit ASCII + Latin 1, 5-0: (001101)b, 13-Byte Allocation PRODUCT SERIAL NUMBER: MODEL ID + MANUFACTURING YEAR & WEEK CODE + UNIQUE SERIAL NUMBER + MODEL REV LEVEL + MANUFACTURING LOCATION (Z - Zhongshan, China) "J" = 4AH "6" = 36H "7" = 37H "5" = 35H "H" = 48H "S" = 53H "0" = 30H "0" = 30H "1" = 31H "J" = 4AH	74	4A	
83	53		50	32	
84	54		55	37	
85	55		48	30	
86	56		87	57	
87	57		87	57	
88	58		83	53	
89	59		83	53	
90	5A		83	53	
91	5B		83	53	
92	5C		"0" = 30H	48	30
93	5D		"A" = 41H	65	41
94	5E		"Z" = 50H	80	5A
95	5F		ASSET TAG (0C8H)	200	C8
96	60	*REFER TO 417-00201000 FOR DETAILS 7-6: (11)b, 8-Bit ASCII + Latin 1, 5-0: (001000)b, 8-Byte Allocation NO ASSET TAG	0	00	
97	61		0	00	
98	62		0	00	
99	63		0	00	
100	64		0	00	
101	65	FRU File ID (0CCH)	0	00	
102	66		0	00	
103	67		0	00	
104	68		204	CC	
105	69		0	00	
106	6A		0	00	
107	6B		0	00	
108	6C		0	00	
109	6D		0	00	
110	6E		0	00	
111	6F		0	00	
112	70		0	00	
113	71		0	00	
114	72		0	00	
115	73		0	00	
116	74		0	00	

Technical Reference Note

Rev.12.07.17 #1.7
DS460S-3 Series
Page 35

DS460S-3-002 FRU (EEPROM) Data:

OFFSET		DEFINITION	SPEC VALUE	
(DEC)	(HEX)	(REMARKS)	(DEC)	(HEX)
117	75	END OF FIELDS MARKER (0C1H)	193	C1
118	76	RESERVED	0	00
119	77	ZERO CHECK SUM (PRODUCT INFO) [256d - (Sum of bytes 40d to 118d)]	124	7C
MULTI RECORD AREA : Power Supply Information (72 bytes)				
Power Supply Record Header				
120	78	Record Type ID (0x00 = Power Supply Information)	0	00
		7: (0)b, End of List 6-4: (000)b, Reserved		
121	79	3-0: (0010)b, Record Format Version	2	02
122	7A	Record Length: 24 Bytes	24	18
123	7B	Record Checksum (Zero Checksum from 125d to 148d)	114	72
124	7C	Header Checksum (Zero Checksum from 120d to 123d)	116	74
Power Supply Record				
125	7D	Overall Capacity (Watts)	204	CC
126	7E	15-12: (0000)b, Reserved 11-0: (001000100110)b, 460W = 01CCH Stored with LSB first then MSB.	1	01
127	7F	Peak VA (Watts)	40	CC
128	80	15-12: (0000)b, Reserved 11-0: (001001111000)b, 552W = 0228H Stored with LSB first then MSB.	2	01
129	81	Inrush Current (Amps) 30Amps = 1EH	30	1E
130	82	Inrush Interval (ms) 5ms = 05H	5	05
131	83	Low End Input Voltage Range 1	40	28
132	84	90 (x10mV) = 9000, 2328H Stored with LSB first then MSB.	35	23
133	85	High End Input Voltage Range 1	144	90
134	86	132 (x10mV) = 13200, 3390H Stored with LSB first then MSB.	51	33
135	87	Low End Input Voltage Range 2	80	50
136	88	180 (x10mV) = 18000, 4650H Stored with LSB first then MSB.	70	46
137	89	High End Input Voltage Range 2	32	20
138	8A	264 (x10mV) = 26400, 6720H Stored with LSB first then MSB.	103	67
139	8B	Low End Input Frequency Range , 47Hz = 2FH	47	2F
140	8C	High End Input Frequency Range, 63Hz = 3FH	63	3F
141	8D	AC Dropout Tolerance in ms , 10ms = 0AH	10	0A
142	8E	Binary Flags 7-5: (000)b, Reserved 4: (1)b, Tachometer Pulses per Rotation / Predictive Fail Polarity (2 Pulses Per Rotation = 1; 1 Pulse Per Rotation = 0) OR Signal Asserted(1) Indicates Failure = 0 Signal Deasserted(0) Indicates Failure = 1) 3: (1)b, Hot Swap / Redundancy Support 2: (0)b, AutoSwitch Support 1: (1)b, Power Factor Correction Support 0: (0)b, Predictive Fail Support	26	1A
143	8F	Peak Wattage Capacity and Holdup Time	40	28
144	90	15-12: (0011)b, Hold Up Time in Seconds = 1 sec 11-0: (001000101000)b, Peak Capacity in Watts = 552 W	18	12

Technical Reference Note

Rev.12.07.17 #1.7
DS460S-3 Series
Page 36

DS460S-3-002 FRU (EEPROM) Data:

OFFSET		DEFINITION	SPEC VALUE	
(DEC)	(HEX)	(REMARKS)	(DEC)	(HEX)
145	91	Combined Wattage NOT APPLICABLE	0	00
146	92		0	00
147	93		0	00
148	94	Predictive Fail Tachometer Lower Threshold , Not applicable	0	00
12V DC OUTPUT RECORD HEADER				
149	95	Record Type ID (0x01 = DC Output)	1	01
		End Of List/Record Format Version Number 7: (0)b, End of List 6-4: (000)b, Reserved 3-0: (0010)b, Record Format Version		
150	96		2	02
151	97	Record Length: 13 Bytes	13	0D
152	98	Record Checksum (Zero Checksum From 154d To 166d)	209	D1
153	99	Header Checksum (Zero Checksum From 149d To 152d)	31	1F
+12V DC OUTPUT RECORD				
154	9A	+12V Output Information 7:7 (0)b, Standby 6:4 (000)b, Reserved 3:0 (0001)b, Output Number 1 = 1H	1	01
155	9B	Nominal Voltage 12.30V = 1230 (x10mV) = 04CEH Stored with LSB first then MSB.	206	CE
156	9C		4	04
157	9D	Nominal Voltage 12.30V = 1230 (x10mV) = 04CEH Stored with LSB first then MSB.	136	88
158	9C		4	04
159	9F	Maximum Positive Voltage Deviation 12.60 x 10mV = 1260, 04ECH Stored with LSB first then MSB.	236	EC
160	A0		4	04
161	A1	Ripple And Noise pk-pk 10Hz to 30MHz (mV) 120mV = 0078H Stored with LSB first then MSB.	120	78
162	A2		0	00
163	A3	Minimum Current Draw 1A x 10mA = 100 , 0064H Stored with LSB first then MSB.	100	64
164	A3		0	00
165	A5	Maximum Current Draw (10mA) 38.30A x 10mA = 3830 , 0EF6H Stored with LSB first then MSB.	246	F6
166	A6		14	0E
12VSB DC OUTPUT RECORD HEADER				
167	A7	Record Type ID (0x01 = DC Output)	1	01
		End Of List/Record Format Version Number 7: (1)b, End of List 6-4: (000)b, Reserved 3-0: (0010)b, Record Format Version		
168	A8		130	82
169	A9	Record Length: 26 Bytes	26	1A
170	AA	Record Checksum (Zero Checksum From 172d To 197d)	239	EF
171	AB	Header Checksum (Zero Checksum From 167d To 170d)	116	74
12VSB DC OUTPUT RECORD				
172	AC	12VSB Output Information 7: (1)b, Standby (Bit = 1 to indicate standby output) 6-4: (000)b, Reserved 3-0: (0010)b, Output Number 2 = 010b	130	82

Technical Reference Note

DS460S-3-002 FRU (EEPROM) Data:

OFFSET		DEFINITION	SPEC VALUE	
(DEC)	(HEX)	(REMARKS)	(DEC)	(HEX)
173	AD	Nominal Voltage 12.0 x 10mV = 1200, 04B0H Stored with LSB first then MSB.	176	B0
174	AE		4	04
OEM RECORD				
175	AF	Maximum Negative Voltage Deviation 10.80 x 10mV = 1080, 0438H Stored with LSB first then MSB.	56	38
176	B0		4	04
177	B1	Maximum Positive Voltage Deviation 13.20 x 10mV = 1320, 0528H Stored with LSB first then MSB.	40	28
178	B2		5	05
179	B3	Ripple And Noise pk-pk (mV) 120mV = 0078H Stored with LSB first then MSB.	120	78
180	B4		0	00
181	B5	0000 = 0000H	0	00
182	B6	Stored with LSB first then MSB.	0	00
183	B7	Maximum Current Draw (10mA) 2.5A x 10mA = 250, 00FAH Stored with LSB first then MSB.	250	FA
184	B8		0	00
185	B9	Reserved	0	00
186	BA	Reserved	0	00
187	BB	Reserved	0	00
188	BC	Reserved	0	00
189	BD	Reserved	0	00
190	BE	Reserved	0	00
191	BF	Reserved	0	00
192	C0	Reserved	0	00
193	C1	Reserved	0	00
194	C2	Reserved	0	00
195	C3	Reserved	0	00
196	C4	Reserved	0	00
197	C5	Reserved	0	00
INTERNAL USE AREA, 64 BYTES				
198	C6	Format Version Number 7:4 -reserved, write as 0000b 3:0 -format version number = 1h for this specification.	0	00
199	C7	PRIMARY FIRMWARE PART NUMBER LENGTH (In multiples of 8 bytes)	0	00
200	C8	“6” = 36H	54	36
201	C9	“3” = 33H	51	33
202	CA	“0” = 30H	48	30
203	CB	“0” = 30H	48	30
204	CC	“6” = 36H	54	36
205	CD	“5” = 35H	53	35
206	CE	“2” = 32H	50	32
207	CF	“-” = 2DH	45	2D
208	D0	“0” = 30H	48	30
209	D1	“0” = 30H	48	30
210	D2	“0” = 30H	48	30
211	D3	“0” = 30H	48	30
212	D4	“ ” = 20H	32	20
213	D5	“r” = 72H	114	72

Technical Reference Note

Rev.12.07.17 #1.7
DS460S-3 Series
Page 38

DS460S-3-002 FRU (EEPROM) Data:

OFFSET		DEFINITION	SPEC VALUE	
(DEC)	(HEX)	(REMARKS)	(DEC)	(HEX)
214	D6	“e” = 65H	101	65
215	D7	“v” = 76H	118	76
216	D8	“A” = 42H	66	42
217	D9	SECONDARY FIRMWARE PART NUMBER LENGTH (In multiples of 8 bytes)	18	00
218	DA	“6” = 36H	54	36
219	DB	“3” = 33H	51	33
220	DC	“0” = 30H	48	30
221	DD	“0” = 30H	48	30
222	DE	“6” = 36H	54	36
223	DF	“5” = 35H	53	35
224	E0	“3” = 33H	51	33
225	E1	“-” = 2DH	45	2D
226	E2	“0” = 30H	48	30
227	E3	“0” = 30H	48	30
228	E4	“0” = 30H	48	30
229	E5	“0” = 30H	48	30
230	E6	“ ” = 20H	32	20
231	E7	“r” = 72H	114	72
232	E8	“e” = 65H	101	65
233	E9	“v” = 76H	118	76
234	EA	“A” = 41H	65	41
235	EB	PMBUS MCU FIRMWARE PART NUMBER LENGTH (In multiples of 8 bytes)	18	00
236	EC	“6” = 36H	54	36
237	ED	“3” = 33H	51	33
238	EE	“0” = 30H	48	30
239	EF	“0” = 30H	48	30
240	F0	“6” = 36H	54	36
241	F1	“2” = 32H	50	32
242	F2	“7” = 37H	55	37
243	F3	“-” = 2DH	45	2D
244	F4	“0” = 30H	48	30
245	F5	“0” = 30H	48	30
246	F6	“0” = 30H	48	30
247	F7	“0” = 30H	48	30
248	F8	“ ” = 20H	32	20
249	F9	“r” = 72H	114	72
250	FA	“e” = 65H	101	65
251	FB	“v” = 76H	118	76
252	FC	“C” = 43H	67	43
253	FD		0	00
254	FE		0	00
255	FF	ZERO CHECK SUM (INTERNAL USE AREA) [256-(Sum of bytes 200d to 254d)]	255	FF

DS460S-3-003 FRU (EEPROM) deviations:

OFFSET		DEFINITION (REMARKS)	SPEC VALUE	
(DEC)	(HEX)		(DEC)	(HEX)
PRODUCT INFORMATION AREA				
		PRODUCT NAME		
52	34	"D" = 44h	68	44
53	35	"S" = 53h	83	53
54	36	"4" = 34h	52	34
55	37	"6" = 36h	54	36
56	38	"0" = 30h	48	30
57	39	"S" = 53h	83	53
58	3A	"-" = 2Dh	45	2D
59	3B	"3" = 33h	51	33
60	3C	"- " = 2Dh	45	2D
61	3D	"0" = 30h	48	30
62	3E	"0" = 30h	48	30
63	3F	"3" = 33h	51	33
		P/N: 417-00201000 7-6: (11)b, 8-Bit ASCII + Latin 1, 5-0: (001101)b, 13-Byte Allocation PRODUCT SERIAL NUMBER: MODEL ID + MANUFACTURING YEAR & WEEK CODE + UNIQUE SERIAL NUMBER + MODEL REV LEVEL + MANUFACTURING LOCATION (Z - Zhongshan, China)		
82	52	"J" = 4AH	74	4A
83	53	"6" = 36H	54	36
84	54	"7" = 37H	55	37
85	55	"6" = 36H	54	36
86	56	"H" = 48H	72	48
87	57	"S" = 53H	83	53
88	58	"0" = 30H	48	30
89	59	"0" = 30H	48	30
90	5A	"0" = 30H	48	30
91	5B	"U" = 55H	85	55
119	77	ZERO CHECK SUM (PRODUCT INFO) [256d - (Sum of bytes 40d to 118d)]	113	71

PMBus™ Interface Support

The DS460S-3 is compliant with the industry standard PMBus™ protocol for monitoring and control of the power supply via the I²C interface port.

DS460S-3 Series PMBus™ General Instructions

Equipment Setup

The following is typical I²C communication setup:

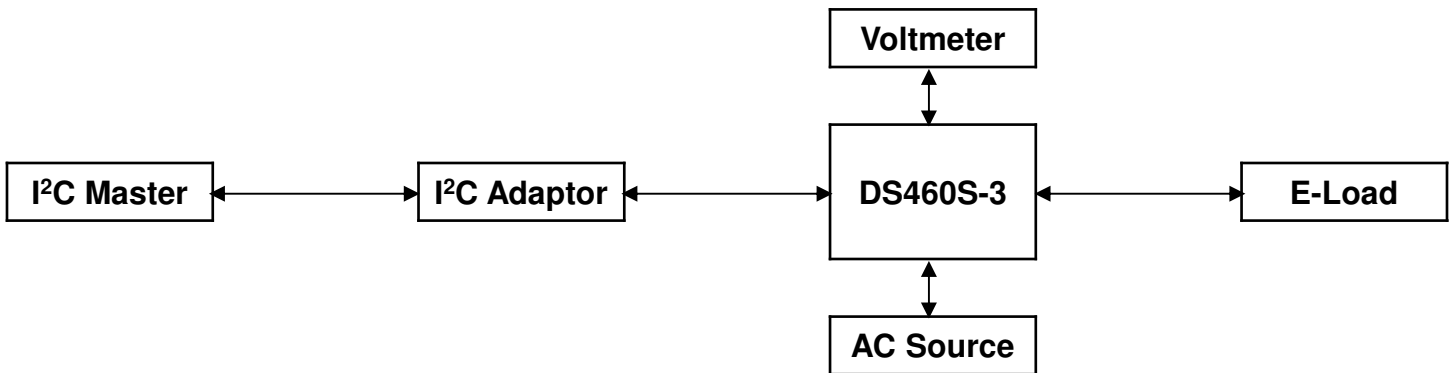

PMBus™ Writing Instructions

When writing to any PMBus™ R/W registers, ALWAYS do the following:

Disable Write Protect (command 10h) by writing any of the following accordingly:

Levels: 00h – Enables write to all write able commands.

80h – Disables all but WRITE_PROTECT

Wait for 5 seconds, turn-off the PSU, wait for another 5 seconds before turning it on.

DS460S-3 Series Support PMBus™ Command List

The DS460S-3 is compliant with the industry standard PMBus™ protocol for monitoring and control of the power supply via the I²C interface port.

DS460S-3 Series Supported PMBus™ Command List:

Command Code	Command Name	Default Value	Access Type	Data Bytes	Data Format	Description
01h	OPERATION	80h	R/W	1		80h – PSU On (if PS_ON# pin is low, too) 40h – PSU Standby (regardless of PS_ON# pin) All else – Invalid)
	b7:6	10b				01 – Soft Turn OFF (With Sequencing) 10 – PSU ON
	b5:4	00b				
	b3:2	00b				
	b1:0	00b				Reserved
02h	ON_OFF_CONFIG	1C	R	1		Reports 0x1C
	b7:5	000				Reserved
	b4 – Enable CONTROL pin and Serial communication control.	1				0 – Unit powers up any time power is present regardless of the state of CONTROL pin. 1 – Unit powers up as dictated by CONTROL pin and OPERATION command (b3:0)
	b3 – Serial communication Control	1				0 – Unit Ignores ON/OFF portion of the OPERATION command. 1 – Enables Serial communication ON/OFF portion of OPERATION command. Requires CONTROL pin to be asserted for the unit to start and energize the output.
	b2 – Sets how the unit responds to CONTROL pin	1				0 – Unit ignores CONTROL pin. (ON/OFF controlled by OPERATION command). 1 – Unit requires CONTROL pin to be asserted to start the unit.
	b1 - CONTROL pin polarity	0				0 – Unit ignores CONTROL pin. (ON/OFF controlled by OPERATION command). 1 – Unit requires CONTROL pin to be asserted to start the unit.
	b0 – CONTROL pin Action	0				0 – Use programmed turn ON/OFF delay 1 – Turn OFF the output and stop transferring energy to the output as fast as possible.
03h	CLEAR_FAULTS	0	S	0		Writing anything to this register will clear the status bytes. It does not restart the supply. If the fault is still present, it will reset the appropriate status bits.
10h	WRITE_PROTECT	80	R/W	1		Used to Control Writing to the PMBus Device 80h - Disables write except 10h 00 – Enables write to all write able commands.
20h	VOUT_MODE	18	R	1		(Read only) Returns the mantissa for the READ_VOUT. Will always return 0x18 (N = -8) if read.
	b 7-5	000b				000b – Linear 001b - VID 010b – Direct
	b 4-0					Five bit two's complement exponent for the mantissa delivered as the data bytes for an output voltage related command. – Linear Five bit VID code identifier per - VID Always set to 00000b - Direct

DS460S-3 Series Supported PMBus™ Command List:

Command Code	Command Name	Default Value (HEX)	Access Type	Data Bytes	Data Format	Description
31h	POUT_MAX	01CC	R	2	Linear	Sets the operating power limit condition. 460W
35h	VIN_ON	EAD0	R	2	Linear	Sets the value of input, in volts, at which the unit should start, 90Vac
36h	VIN_OFF	EA80	R	2	Linear	Sets the value of input, in volts, at which the unit should stop power conversion., 80Vac
3Ah	FAN_CONFIG_1_2	D0	R	1		Used to configure up to 2 fans associated with one PMBus device
	b 7	1				1 – Fan is installed in position 1 0 – No Fan is installed in position 1
	b 6	0				1 – Fan is commanded in RPM 0 – Fan is commanded in DC
	b 5:4	01				00 – 1 pulse per revolution 01 – 2 pulses per revolution 10 – 3 pulses per revolution 11 – 4 pulses per revolution
	b 3	0				1 – Fan is installed in position 2 0 – No Fan is installed in position 2
	b 2	0				1 – Fan is commanded in RPM 0 – Fan is commanded in DC
	b1:0	00				00 – 1 pulse per revolution 01 – 2 pulses per revolution 10 – 3 pulses per revolution 11 – 4 pulses per revolution
3Bh	FAN_COMMAND_1 ²	00	R/W	2	Direct	Adjusts the operation of the Fans. The device may override the command, if it requires higher value, to maintain proper device temperature. This command requires PWM duty cycle as its input data. (e.g. 100% duty; data = 0x0064) Valid range is 0-100.
40h	VOUT_OV_FAULT_LIMIT ³	0D99	R	2	Linear	Sets Output Over voltage threshold, 13.6V
41h	VOUT_OV_FAULT_RESPONSE	80	R	1		Unit Latches OFF. Resets on PSON or CONTROL pin recycle or AC input recycle
42h ²	VOUT_OV_WARN_LIMIT ³	0D00	R/W	2	Linear	Sets Output Over-voltage Warning threshold. 13.0V
						Command code only accepts write data from 12.3V to 16V(0x0C0C to 0x1000)
43h ²	VOUT_UV_WARN_LIMIT ³	0B00	R/W	2	Linear	Sets Output Under-voltage Warning threshold.11.0V
						Command code only accepts write data from 8.6V to 12V(0x0899 to 0x0C00)
44h	VOUT_UV_FAULT_LIMIT ³	0B00	R	2		Sets Under-voltage Fault threshold, 11.0V
45h	VOUT_UV_FAULT_RESPONSE	80	R	1		Unit Latches OFF. Resets on PSON pin recycle or AC recycle.
4Fh	OT_FAULT_LIMIT	F258	R	2		Internal temperature Fault threshold, in degree C, 150degC.
50h	OT_FAULT_RESPONSE	B8	R	1		Turns-off but retries indefinitely.
51h	OT_WARN_LIMIT ²	F140	R/W	2	Linear	Internal temperature warning threshold, in degree C,80degC
						Command code only accepts write data from 70degC to 140degC (0xF118 to 0xF230)
55h	VIN_OV_FAULT_LIMIT	FA1E	R	2	Linear	Sets input over-voltage threshold, 271Vac.
56h	VIN_OV_FAULT_RESPONSE	00	R	1		No interruption.

DS460S-3 Series Supported PMBus™ Command List:

Command Code	Command Name	Default Value (HEX)	Access Type	Data Bytes	Data Format	Description
57h	VIN_OV_WARN_LIMIT ²	FA1C	R/W	2	Linear	Sets the threshold of input voltage that triggers high voltage warning, 270Vac.
						Command code only accepts write data from 241 to 290 (0xF9E2 to 0xFA44).
58h	VIN_UV_WARN_LIMIT ²	F8A0	R/W	2	Linear	Sets the threshold of input voltage that triggers under-voltage warning, 80Vac
						Command code only accepts write data from 50V to 99V (0xF864 to 0xF8C6).
78h	STATUS_BYTE	-	R	1		Returns the summary of critical faults
	b7					Not supported
	b6					Main Output is OFF
	b5 - VOUT_OV					Output over-voltage fault has occurred
	b4 - IOUT_OC					Output over-current fault has occurred
	b3					Not supported
	b2 - TEMPERATURE					A temperature fault or warning has occurred
	b1 - CML					CML error
	b0 - Fan Fault					Fan fault occurred
79h	STATUS_WORD	-	R	2		Summary of units Fault and warning status.
	b15 - VOUT					An output voltage fault or warning has occurred
	b14 - IOUT/POUT					An Output current or power fault or warning has occurred.
	b13 - INPUT					An input voltage, current or power fault or warning as occurred.
	b12					Not supported
	b11					Input loss or fault has occurred
	b10					A fan or airflow fault or warning has occurred
	b9:8					Not supported
	b7:0					*Same as STATUS_BYTE*
7Ah	STATUS_VOUT	-	R	1		Output voltage related faults and warnings
	b7					VOUT Over-voltage Fault
	b6					VOUT Over-voltage warning
	b5					VOUT Under-voltage Warning
	b4:0					Not supported
7Bh	STATUS_IOUT	-	R	1		Output Current related faults and warnings
	b7					IOUT Over current Fault
	b6:0					Not supported
7Ch	STATUS_INPUT	-	R	1		Input related faults and warnings
	b7					Not supported
	b6					VIN Overvoltage Warning
	b5					VIN Undervoltage Warning
	b4					Not supported
	b3					Unit is OFF for insufficient Input Voltage
	b2:0					Not supported
7Dh	STATUS_TEMPERATURE	-	R	1		Temperature related faults and warnings
	b7					Over temperature Fault
	b6					Over temperature Warning
	B5:4					Not supported
	B3:0					Reserved

DS460S-3 Series Supported PMBus™ Command List:

Command Code	Command Name	Default Value (HEX)	Access Type	Data Bytes	Data Format	Description
7Eh	STATUS_CML					
	b7					Not supported
	b6					Invalid or unsupported Data Received
	b5					Not supported
	b4					Not supported
	b3:0					Reserved
81h	STATUS_FANS_1_2	-	R	1		PSU Fan related faults and warnings
	b7					Fan 1 Fault
	b6:4					Not supported
	b3					Fan 1 Speed Overridden
	b2:0					Not supported
88h	READ_VIN	-	R	2	Linear	Returns input Voltage in Volts ac.
89h	READ_IIN	-	R	2	Linear	Returns input Current in Amperes
8Bh	READ_VOUT	-	R	2	Linear	Returns the actual, measured voltage in Volts.
8Ch	READ_IOUT	-	R	2	Linear	Returns the output current in amperes.
8Dh	READ_TEMP_1	-	R	2	Linear	Ambient temperature sensor
8Eh	READ_TEMP_2	-	R	2	Linear	Internal temperature sensor
90h	READ_FAN_SPEED_1	-	R	2	Linear	Speed of Fan 1
96h	READ_POUT	-	R	2	Linear	Returns the output power, in Watts.
97h	READ_PIN	-	R	2	Linear	Returns the input power, in Watts.
98h	PMBUS_REVISION	11	R	1		Reads the PMBus revision number
	b7:4	0001				Part 1 Revision 0000 – Revision 1.0 0001 – Revision 1.1
	b3:0	0001				Part 2 Revision 0000 – Revision 1.0 0001 – Revision 1.1
99h	MFR_ID	4E4F 5352 454D 4507	R	8		Manufacturers name, , ASCII format “EMERSON “
9Ah	MFR_MODEL	3036 3453 4405	R	6		Power Supply Model Name “DS460”
A0h	MFR_VIN_MIN	-	R	2	Linear	Minimum Input Voltage, 90Vac
A1h	MFR_VIN_MAX	-	R	2	Linear	Maximum Input Voltage, 264Vac
A2h	MFR_IIN_MAX	-	R	2	Linear	Maximum Input Current, 6.0A
A3h	MFR_PIN_MAX	-	R	2	Linear	Maximum Input Power, 600W
A4h	MFR_VOUT_MIN ³	-	R	2	Linear	Minimum Output Voltage Regulation Window 11.85Vdc
A5h	MFR_VOUT_MAX ³	-	R	2	Linear	Maximum Output Voltage Regulation Window 12.5Vdc
A6h	MFR_IOUT_MAX	-	R	2	Linear	Maximum Output Current, 38.3A
A7h	MFR_POUT_MAX	-	R	2	Linear	Maximum Output Power, 460W
A8h	MFR_TAMBIENT_MAX	-	R	2	Linear	Maximum Operating Ambient Temperature, 50degC
A9h	MFR_TAMBIENT_MIN	-	R	2	Linear	Minimum Operating Ambient Temperature, 5degC

Note 2 : For command codes with R/W access type, there is a possibility that some data (in bits) will be lost. This is due to computation/conversion loss. For example, if you write data 0xAABB on command code FFh, then read the command code after a successful write, 0xAABB will be the data written into FFh. A ± 5 bits is the allowable tolerance

Note 3 : VOUT related commands requires N from VOUT_MODE, in this model N = -8.

Application Notes

Current Sharing

The DS460S-3 series' main output is equipped with current sharing capability. 12V output current from each power supply shall be within (+10%, -10%) of I load / when supplying total output load current of 0.5I max. < I load < I max. where, I max. = 36A for 2 power supplies connected in parallel. All current sharing functions shall be implemented internal to the power supply. The supplies shall be able to load share with 2 power supplies in parallel and operate in a hot swap/redundant n+1 configuration.

12VSB is required to share current between active power supplies, current share accuracy between active power supplies for this output shall be within (+50%, -50%) of Iload.

Examples of load share accuracy at limits of acceptability (+10%, -10% sharing):

2 power supplies and system load equals 38.3A: PS #1 = 17.3A, PS #2 = 21A

2 power supplies and system load equals 65.5A: PS #1 = 36A, PS #2 = 29.5A

Maximum total power equals 827.3W: PS #1 = 459.6W, PS #2 = 367.7W

Redundancy/Fault Tolerance

The DS460 series power supplies can be connected in the following to provide redundancy/fault tolerance operation:

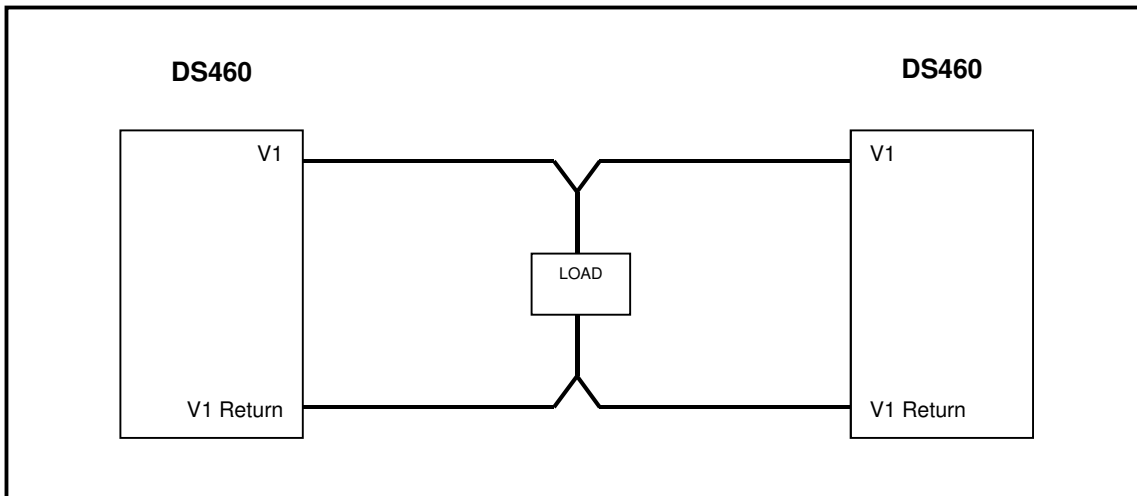

The DS460S-3 series power supplies will allow up to 8 power supplies to be connected in an N+1 redundant Load. Any failure of one power supply in parallel as well as hot swapping shall not cause more than a 5% change in main output, 10% change in standby output (see Table 9). Current share accuracy is typically 10% of full load. The Failure of one or more supplies will not cause the remaining supplies to violate any of the input or output specifications noted in this specification including all status signals.

The latch of the DS460S-3 power supply is designed to prevent the latch from depressed if the AC cord is attached to the power supply. In order to remove the power supply from system chassis, the AC cord must be removed first so the power supply will always be in the powered off state during the removal from system chassis.

Table 9. Output Dynamic Regulation:

Operating Condition	OUTPUT	MIN	MAX	Duration
Normal	12V	11.60V	12.60V	At all time
Normal	12VSB	10.80V	13.20V	At all time

High efficiency redundancy function

DS460S-3 series power supplies has the or'ing function but did not use the traditional separate "STAND ALONE" Or'ing diode implement to maximum efficiency and minimize cost. Instead of a separate "STAND ALONE" or'ing diode/FET, in DS460, the or'ing diode/FET function is distributed into two parts. One is main output rectifier FETs which is in main output path, the second path is the output cap which in parallel to the output which an additional cap FET switch is added for Or'ing function. Since the main output rectifier FETs are required whether or not if there is a separate "STAND ALONE" Or'ing diode in the power supply, so use them for Or'ing FET function do not incur additional power losses. Also the Cap FET switch only have output cap's ripple current flow through so the loss is relatively small. This type of Or'ing function implementation will be used in all types of high efficiency power supplies from gold label and specially the platinum and titanium labeled efficiency power supplies.

Output Ripple and Noise Measurement

The setup outlined in the diagram below has been used for output voltage ripple and noise measurements on the DS460S-3 Series. When measuring output ripple and noise, a scope jack in parallel with a 0.1uF ceramic chip capacitor, and a 10 uF aluminum electrolytic capacitor should be used. Oscilloscope should be set to 20 MHz bandwidth for this measurement.

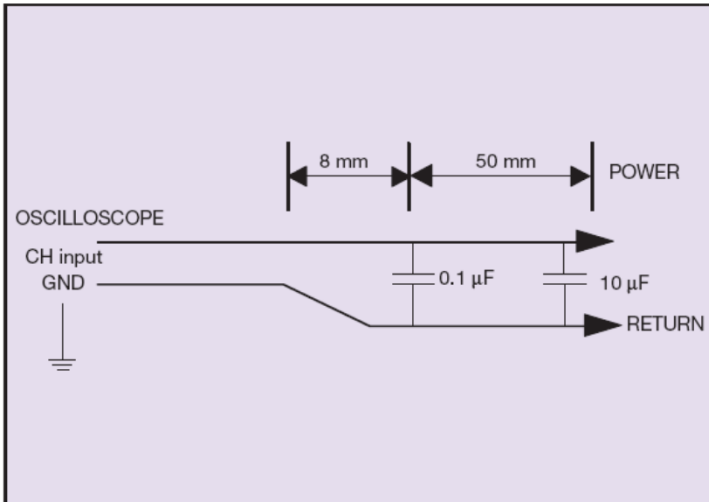

Record of Revision and Changes

Issue	Date	Description	Originators
1.0	10.17.2011	First Issue	K. Wang
1.1	11.23.2012	Update DS460S-3-002/003	K. Wang
1.2	03.15.2013	Update some error	K. Wang
1.3	08.27.2014	Update some error	K. Wang
1.4	04.30.2015	Update Mech drawing (Artesyn)	K. Wang
1.5	05.05.2017	Update the comment list 51h/A6 default value	K. Wang
1.6	09.18.2017	Update EMI level	A. Zhang
1.7	12.07.2017	Update the I ² C timing	A. Zhang

WORLDWIDE OFFICES

Americas

2900 S.Diablo Way
Tempe, AZ 85282
USA
+1 888 412 7832

Europe (UK)

Waterfront Business Park
Merry Hill, Dudley
West Midlands, DY5 1LX
United Kingdom
+44 (0) 1384 842 211

Asia (HK)

14/F, Lu Plaza
2 Wing Yip Street
Kwun Tong, Kowloon
Hong Kong
+852 2176 3333



www.artesyn.com

While every precaution has been taken to ensure accuracy and completeness in this literature, Artesyn Embedded Technologies assumes no responsibility, and disclaims all liability for damages resulting from use of this information or for any errors or omissions. Artesyn Embedded Technologies, Artesyn and the Artesyn Embedded Technologies logo are trademarks and service marks of Artesyn Technologies, Inc. All other names and logos referred to are trade names, trademarks, or registered trademarks of their respective owners.
© 2014 All rights reserved.

For more information: www.artesyn.com/power
For support: productsupport.ep@artesyn.com